

m
Materasso

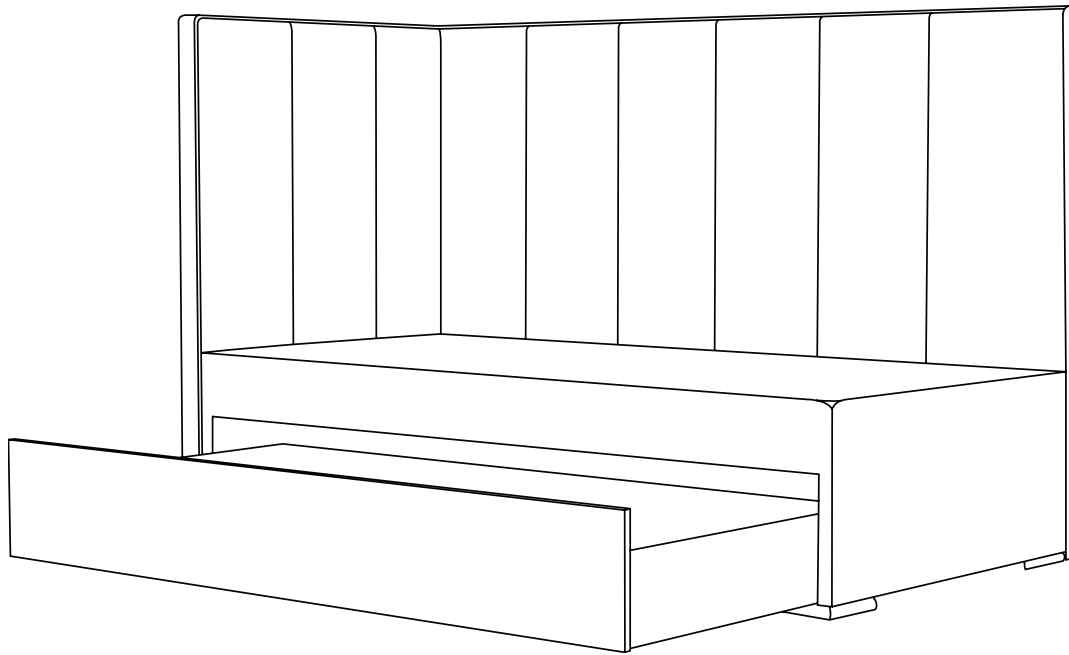

EN

m
Materasso
 For moments that matter...



- 15 DAMIANI SET
- 17 CRISTAL SET
- 19 SPECTRA SET
- 21 CORONA SET
- 23 FRANCESCA LUX SET
- 25 SOUL SET

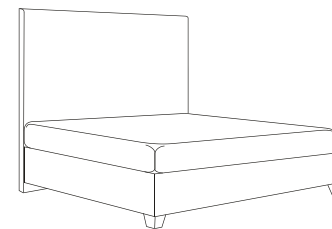

- 27 CHESS
- 29 ZINA
- 31 DUNA
- 33 CRISTAL
- 35 LA SPEZIA
- 37 DAMIANI
- 39 SOUL
- 41 CORIUM
- 43 FORREST
- 45 CHESTERFIELD
- 47 RHOMBUS
- 49 WILD
- 51 KINGSTONE
- 53 HONEY
- 54 MELVA
- 56 SPECTRA

- 58 HORIZONTAL
- 60 NAVY
- 62 ENIF
- 64 GEMINI
- 67 FRANCESCA LUX
- 69 CLAUDIA LUX
- 70 ALESIA
- 73 VEGA
- 75 BELLATRIX
- 76 ATLAS
- 78 CORONA
- 80 PARIS
- 82 VIENNA
- 84 NOBILIA
- 87 ARGENTINA
- 89 SIRIUS
- 91 VELORUM
- 93 CORIUM SLIDE
- 95 WALL
- 97 TWINS

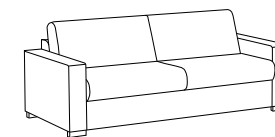

- 99 AMIRA
- 101 SIESTA
- 103 SOFABED BARI
- 105 SOFABED TORVI
- 107 SOFABED SINGLE
- 109 SOFABED DOUBLE

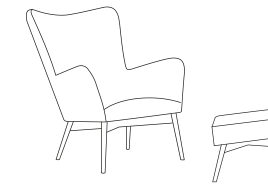

- 110 BOUDOIR MONT BLANC
- 111 MONT BLANC
- 112 BOSS
- 113 MOON
- 114 PUFF
- 116 BOUDOIR BREEZE
- 117 BREEZE
- 118 DE LUXE
- 119 MODERN
- 120 CUT
- 120 CASTELO
- 120 CROSS

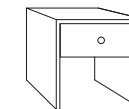

- 121 INDUSTRY
- 121 HEAVY OAK
- 121 OAK
- 122 WHITE
- 122 STONE
- 122 DARK STONE
- 123 CUBE
- 123 DAMIANI
- 123 BIANCA
- 124 TABURET | BENCH



Materasso s.r.o. is a family-owned company that has been in the market for over 30 years.

In the Czech and European markets, and in recent years also in non-European markets, it is renowned for producing certified orthopedic mattresses, designer beds, interior accessories (such as ottomans, armchairs, and nightstands), and bedding accessories (including duvets, pillows, and mattress protectors).

Thanks to our continuously expanding product range, the use of high-quality materials, adherence to certified manufacturing processes, and excellent after-sales service, we continue to grow our base of satisfied customers—both individual clients and professionals, such as interior designers and hoteliers.

The bedroom is the most intimate and important space in your home.

It is a place of rest and relaxation for both your body and senses after a long day. Here, you regain strength and prepare for new challenges.

We understand that the centerpiece of every bedroom is the bed—it gives the room its soul and character. That's why our bed collection is distinguished not only by a solid construction and perfect craftsmanship but also by beautiful design, a wide selection of upholstery fabrics, and various color options.

Combined with our range of orthopedic mattresses, it provides the ultimate comfort and luxury. We place great emphasis on functionality and the ability to create bed models tailored exactly to your needs.

Thanks to a wide variety of shapes, designs, colors, and additional features, you will certainly find the perfect bed in our collection to complete your interior's style—transforming your bedroom into the coziest place in your home.

We build on a strong team of qualified experts with many years of experience in manufacturing orthopedic mattresses and beds, as well as on the quality of our products.

We offer the possibility to combine various sleeping systems with a rich selection of modern headboards in different designs and finishes.

Our production includes various types of bed frames, featuring either slim or robust side panels, as well as standard and custom-length beds. We also manufacture comfortable box spring beds, widely recognized from the hotel industry.

Customers can choose between beds with or without storage space. The selection of bed slats is also customizable—ranging from classic fixed slats to lift-up or electrically adjustable versions.

We continuously monitor new technologies and trends in interior design. Incorporating these innovations into our production has allowed us to create a comprehensive and aesthetically successful collection of beds and complete bedroom sets.

The design and style of our beds are further enhanced by the use of high-quality upholstery fabrics. Our collection includes not only fabrics with unique patterns and textures but also those with special easy-clean treatments, as well as materials resistant to liquid absorption and dirt.

Every bed in our collection, regardless of its frame type, can be customized with a selection of legs in various materials, shapes, and heights to perfectly match your vision.



Mattress Storage Options:

1. RECESSED MATTRESS SYSTEM:

The mattress is recessed into the bed frame, meaning the outer dimensions of the bed are larger than the mattress size.

This option is only possible with frame beds.



2. CORIUM SYSTEM:

The mattress is placed on a sleeping system (frame bed or box spring), with the outer dimensions of the mattress matching the dimensions of the bed's sleeping system.

BED SYSTEMS

Each bed system can be combined with any headboard and legs. You can choose from a wide range of high-quality upholstery fabrics.

For every bed, you can also order an ottoman, an armchair, or a footrest in the same fabric.

The heights of the sleeping systems are listed without legs. All beds within the children's and teenager program are available starting from a width of 90 cm.

The entire bed frame (excluding the headboard and slats) is packed in a cardboard box, making transport easier and providing better protection during handling.

All assembled joints in frame constructions use metric-thread bolts and nuts, allowing for easy and repeated assembly.

ABBREVIATIONS USED:

- UP – Storage space
- BV – Side lift mechanism
- NV – Foot-end lift mechanism

NEW



BOXSPRING SLIDE

The boxspring is designed with a focus on maximum comfort and functionality. Thanks to the combination of pocket springs and a layer of PUR 35 foam in the top section, it provides optimal sleeping comfort. This combination ensures sufficient body support while maintaining flexibility, contributing to a relaxing and healthy sleep.

This boxspring is an ideal choice for those who appreciate the practicality of an integrated extra bed without compromising comfort. The linear sliding mechanism allows for easy and smooth operation. You can choose the mattress for the extra bed according to your preferences, with a maximum mattress height of 20 cm.

NEW



HIGHLIGHT

The box is upholstered in the same fabric as the bed's headboard, and the sleeping surface of the boxspring features a special ANTISLIP-treated fabric that securely holds the mattress in place, preventing any shifting.

The side panel height of the box is 10 cm.



BOXSPRING 22-32 CM

It is the most advanced bed system. Its popularity stems from its specific construction: the robust boxspring frame surrounds the spring core, providing a point-adaptive foundation under the mattress, improving its conforming properties and overall adaptability. This composition creates an exceptional double-contouring system that follows the natural shape of the body.

The boxspring is upholstered in the same fabric as the bed's headboard, and the sleeping surface of the boxspring features a special ANTISLIP-treated fabric that securely holds the mattress in place, preventing any shifting. The side panel height of the boxspring is either 22 or 32 cm. The mattress is not recessed into the bed frame but sits flush with the boxspring.



BOXSPRING UP LIFT MAXI

The UP MAXI 40, UP MAXI 100, and UP MAXI ELECTRIC are the perfect solution for those looking for a comfortable bed with the advantages of boxspring construction, enhanced by a large storage space within the bed. The boxspring construction minimizes the space requirements in the bedroom, allowing for a larger mattress compared to traditional bed types.

The storage space, without internal dividing partitions, offers an exceptionally large area with excellent access across its entire surface. The UP MAXI 40 boxspring can easily lift a mattress with a total weight of up to 40 kg. For heavier mattresses, the UP MAXI 100 system is designed. It features 4 hardware components and gas springs for easy lifting of the storage compartment lid along with heavy mattresses. The lifting mechanism in UP MAXI ELECTRIC is powered by an electric motor. The boxspring height is 32 cm.



UP WOOD

This bed is designed for those who need more storage space in the bedroom and also prefer a single partner mattress. The bed frame is available in thicknesses of 3, 5, or 8 cm, and heights of 30 or 35 cm.

It is equipped with a construction and slats made of solid beech wood. The frame features a front-lifting mechanism with pneumatic gas springs that make it easy to access the storage space, even with heavy mattresses.



UP METAL

This bed is designed for those who need more storage space in the bedroom and also prefer a single partner mattress. The bed frame is available in thicknesses of 3, 5, or 8 cm, and heights of 30 or 35 cm.

It is equipped with a special slatted bed base with a metal construction, which lifts from the front using hardware with pneumatic gas springs, allowing easy access to the storage space even with heavy mattresses. The metal frame of the slats is fitted with pre-tensioned slats. By removing the base of the storage space, you gain access to the entire area under the bed, which is especially useful for cleaning.



UP METAL LIFT-UP

An upgrade to the UP Metal, the METAL LIFT-UP facilitates access to the storage space at the head of the bed and also greatly simplifies changing the bed linens.



UP BV | UP NV

The designer bed UP BV and UP NV (with adjustable headrests) is equipped with wooden lifting slatted bases. For this bed, it is recommended to use two separate mattresses to fully utilize the lifting slats.

The mattress is recessed 6 cm from the top edge of the side panel when using the METAL, DOBLE NV, and DOUBLE BV slats.

In the Corium version, the slats can be mounted at the height of the side panel's top edge, with the mattress supported by both the slats and the side panels. This configuration gives the bed a boxspring-like appearance, and the bed's width (including the side panels) will match the width of the mattress.



WITHOUT STORAGE SPACE

The designer bed is intended for those who do not require storage space within the bed. The bed frame is similar to that of the UP bed but does not include the attachments for the storage base.

This frame can accommodate all types of slatted bed bases under the mattress, from simple solid slatted bases to slatted bases in a frame, flexible slats, adjustable ones, and even models with continuous electric adjustment. This provides complete comfort during sleep and also for moments of active rest, such as reading. The frames are available in different side panel thicknesses: 3, 5, or 8 cm, and three heights: 15, 30, or 35 cm.



BOXSPRING MOBIL

The bed construction is identical to the Boxspring 22/32, enhanced with the function of continuous adjustment for the head, back, and legs using an electric motor with a controller. This type of bed does not have protruding side panels, and the adjustability allows for the best position for rest. There is a different position for sleeping, another for active rest (e. g., reading), and another for the regeneration of sore legs.

The Boxspring Mobil works ideally with mattresses made from cold foam, with anatomically cut cores, latex mattresses, as well as mattresses made from „lazy“ memory foam. These mattresses precisely conform to the slatted base shape when adjusted.

The boxspring height is 32 cm.

BED SETS, UPHOLSTERY FOR WALLS AND ACCESSORIES

A new feature that is highly appreciated not only by interior designers and hoteliers but also increasingly by regular consumers is the option to order stools, nightstands, armchairs, or ottomans in the same upholstery fabric as the bed.

For those who already own a high-quality bed (such as a solid wood bed) and plan to elevate the interior of their bedroom, we offer the possibility to combine individual interior accessories in the same upholstery fabric, either with each other or matching with the upholstered wall behind the headboard. A SET (combination) of the bed and one or all of the mentioned interior accessories in the identical upholstery fabric enhances the overall impression of your bedroom, creating a desired feeling of elegance and luxury, reflecting your unique taste and preferences.





DAMIANI SET

NEW

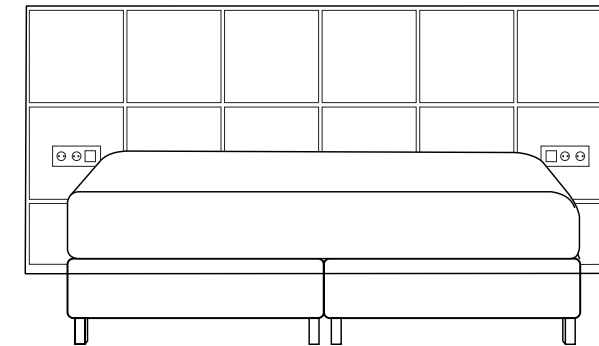

DAMIANI
(p. 37)

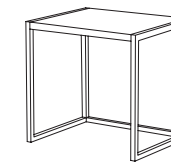
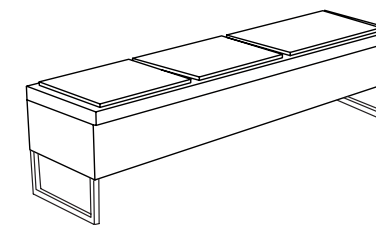

DAMIANI
(p. 123)



CRISTAL SET

NEW

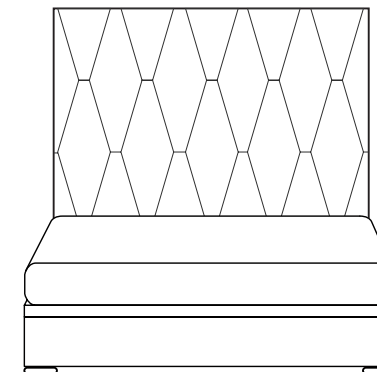

CRISTAL
(p. 33)

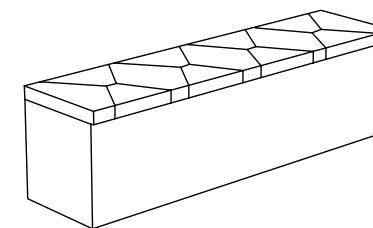

TABURET
No. 5 (p. 125)

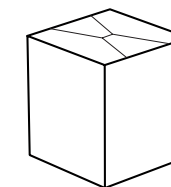

CUBE - CRISTAL
(p. 123)



SPECTRA SET

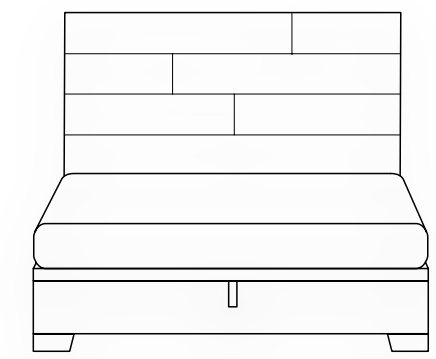

SPECTRA
(p. 56)

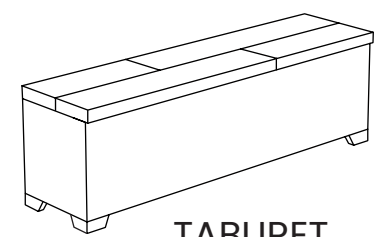

TABURET
No. 7 (p. 125)

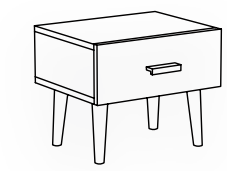

BIANCA
(p. 123)

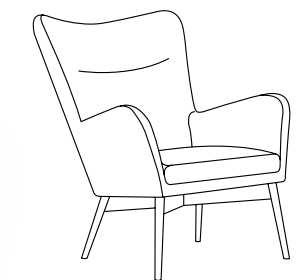

BREEZE
(p. 117)

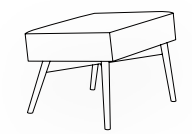

CUT
(p. 120)



CORONA SET

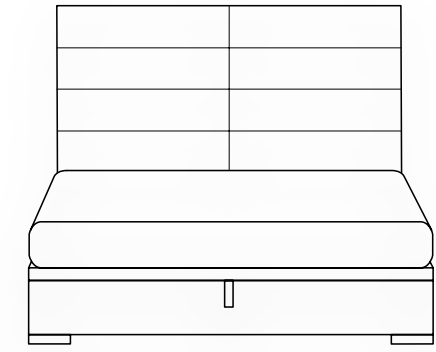

CORONA
(p. 78)

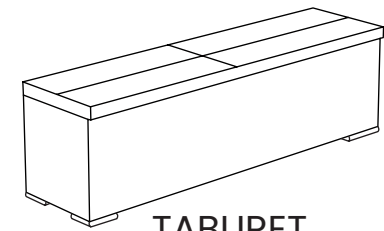

TABURET
No. 4 (p. 125)

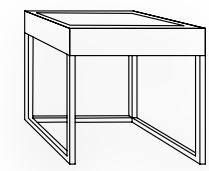

INDUSTRY
(p. 121)

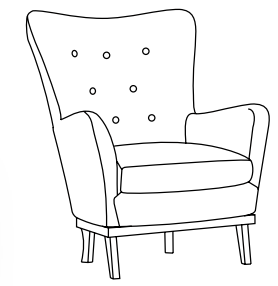

DE LUXE
(p. 118)

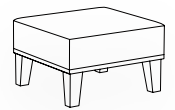

CASTELO
(p. 120)



FRANCESCA LUX SET

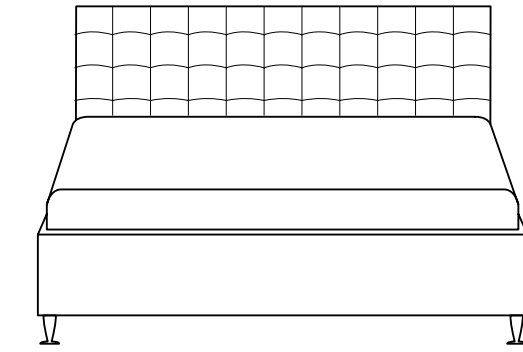

FRANCESCA LUX
(p. 67)

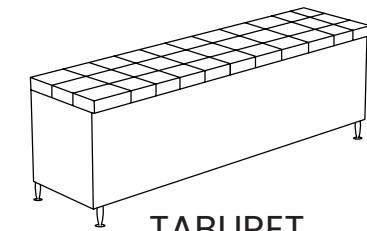

TABURET
No. 12 (p. 125)

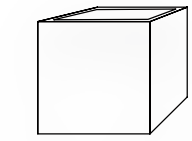

CUBE
(p. 123)

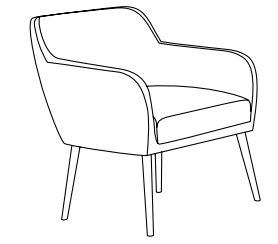

MODERN
(p. 119)



CROSS
(p. 120)



SOUL SET

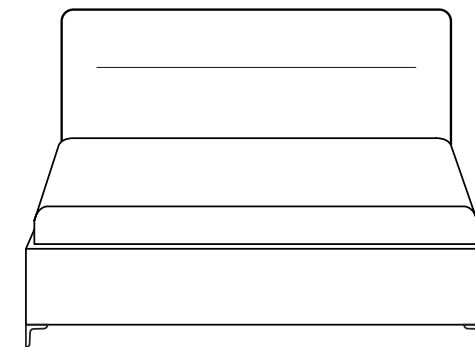

SOUL
(p. 39)

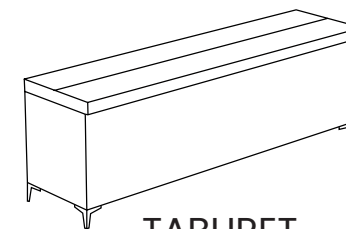

TABURET
No. 1; 3 (p. 125)

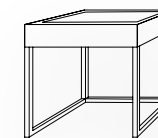

INDUSTRY
(p. 121)

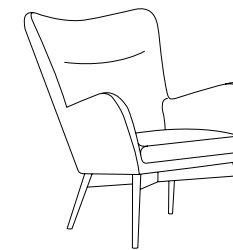

**BREEZE
MIRACH**
(p. 117)



CROSS
(p. 120)



CHESS

NEW

	L	b ^l	b ^w	b ^h	h ^w	h ^h	m ^l	m ^w (cm)
DESING BED	211	205	190	30	270	130	200	180

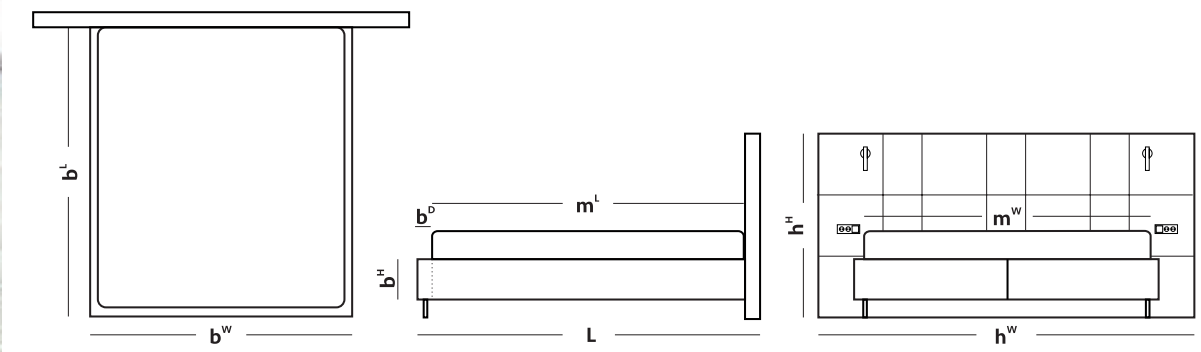



ZINA

NEW

	L	b ^l	b ^w	b ^h	h ^w	h ^h	m ^l	m ^w (cm)
DESING BED	204	200	180	10	316	139	200	180

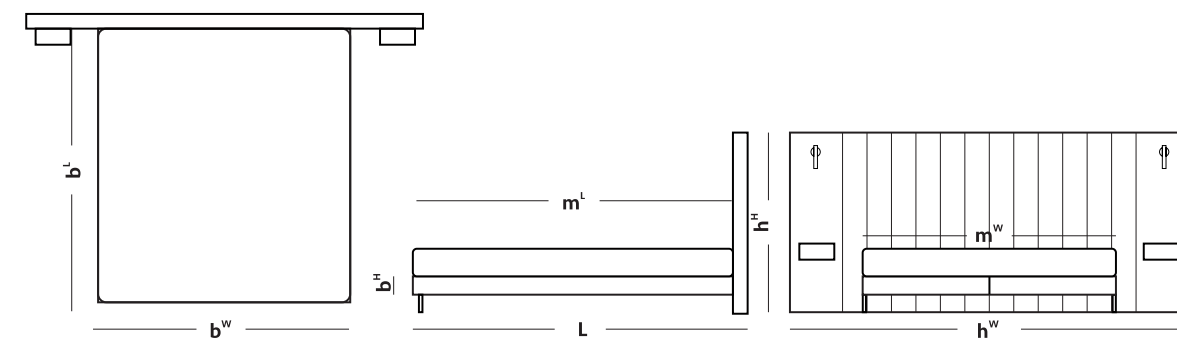



DUNA

NEW

	L	b ^l	b ^w	b ^h	h ^w	h ^h	m ^l	m ^w (cm)
DESING BED	211	205	190	30	190	111	200	180

Taburet
(p. 125)

No. 10

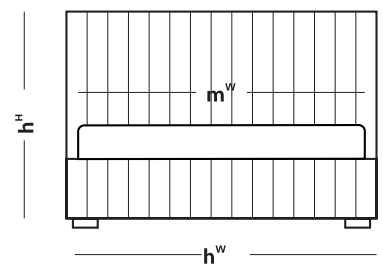
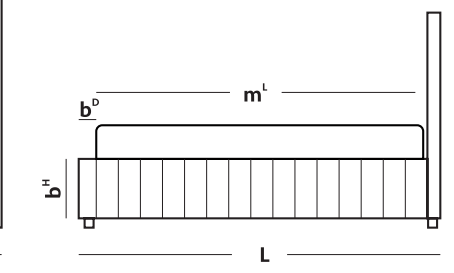
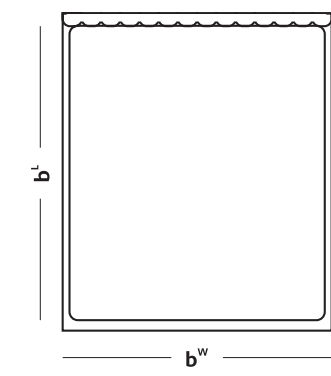
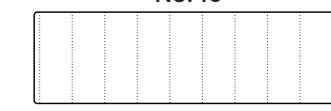



CRISTAL

	L	b ^l	b ^w	b ^h	h ^w	h ^h	m ^l	m ^w (cm)
Maxi Elektro 32	208	200	180	32	180	160	200	180

Taburet
(p. 125)

No. 5

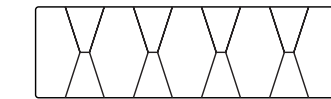

No. 1

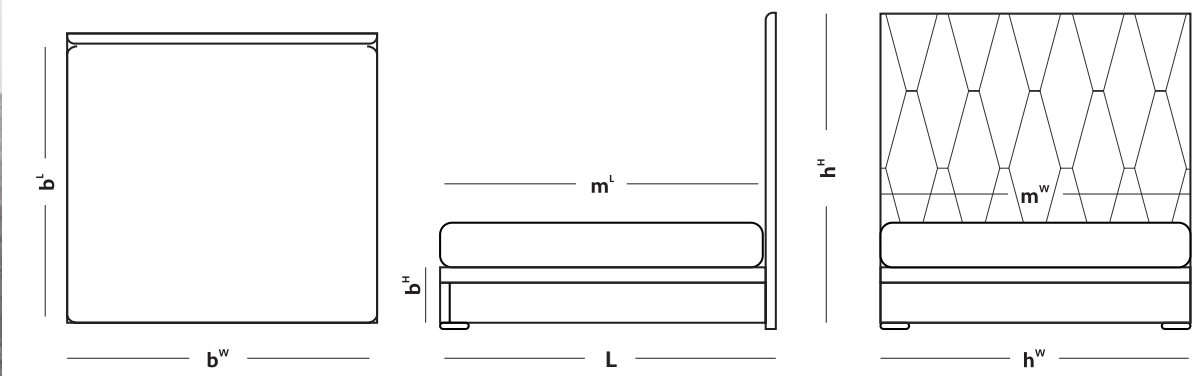



LA SPEZIA

NEW

	L	b ^L	b ^W	b ^H	h ^W	h ^H	m ^L	m ^W (cm)
DESING BED	213	203	186	35	246	135	200	180

Taburet
(p. 125)

No. 1

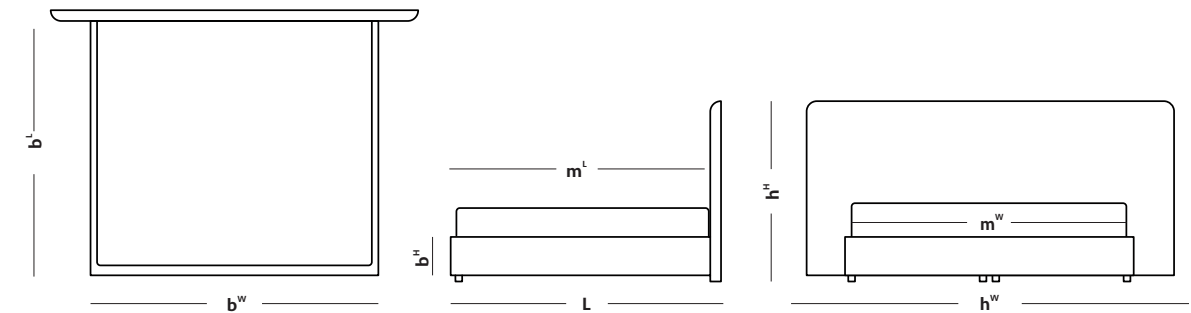



Width 74.0"



17 gal
19 hwy

Front 265/35 ZR 20
Rear 325/30 ZR 21

DAMIANI

NEW

	L	b ^L	b ^W	b ^H	h ^W	h ^H	m ^L	m ^W (cm)
BOXSPRING 22	207	200	180	22	272	122	200	180

Taburet
(p. 124)

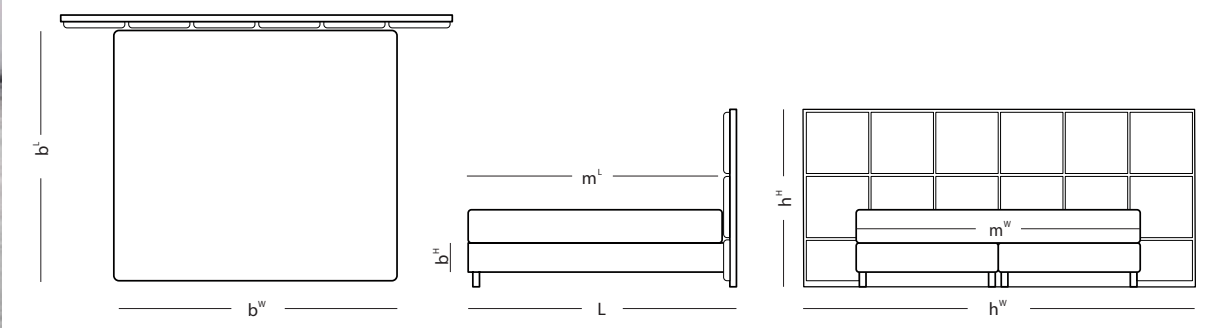
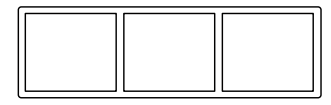



SOUL

NEW

	L	b ^l	b ^w	b ^h	b ^d	h ^w	h ^h	m ^l	m ^w (cm)
DESING BED	216	205	190	35	5	196	120	200	180
TYPE CORIUM	211	200	180	35	5	186	120	200	180

Taburet
(p. 125)

No. 1

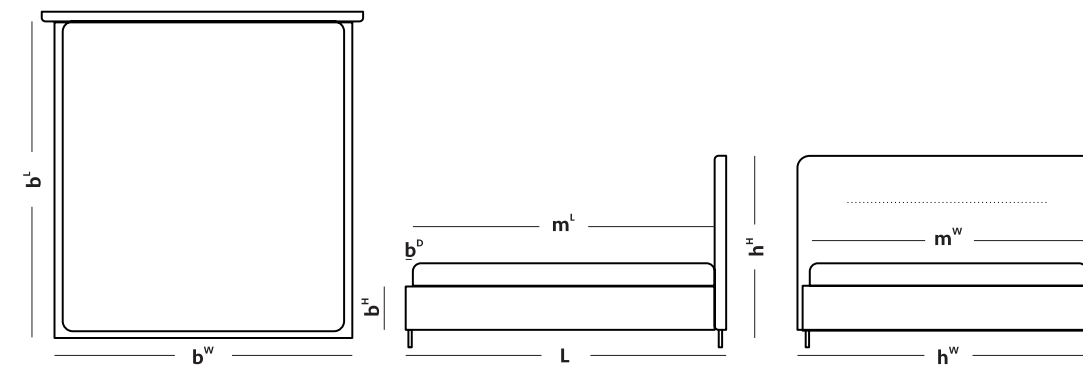



CORIUM

	L	b ^l	b ^w	b ^h	h ^w	h ^h	m ^l	m ^w (cm)
DESING BED	209	200	180	30	180	150	200	180
CORIUM	209	200	160	30	160	150	200	160

Taburet
(p. 125)

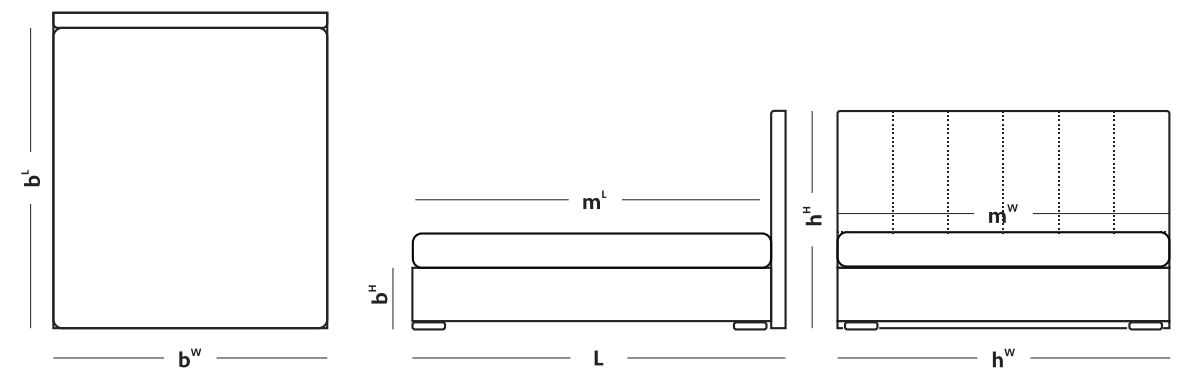
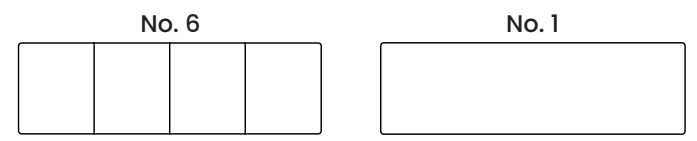



FORREST

	L	b ^l	b ^w	b ^h	h ^w	h ^h	m ^l	m ^w (cm)
BOXSPRING 32	208	200	180	32	180	160	200	180
	208	200	160	32	160	160	200	160

Taburet
(p. 125)

No. 1



No. 18

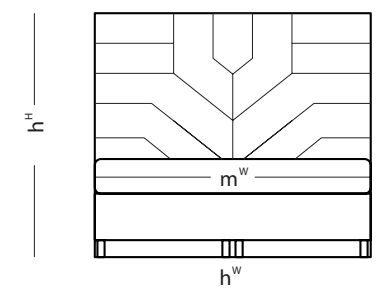
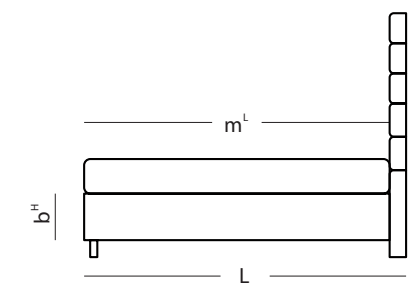
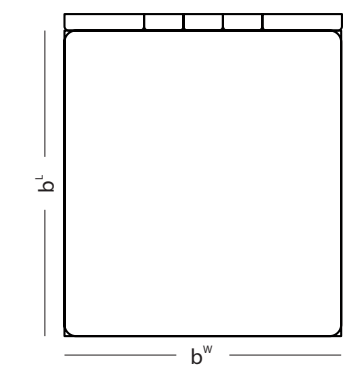
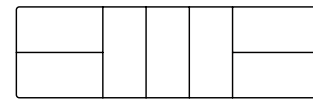



CHESTERFIELD

	L	b ^L	b ^W	b ^H	h ^W	h ^H	m ^L	m ^W (cm)
BOXSPRING 22	213	200	180	22	180	143	200	180
	213	200	160	22	160	143	200	160

Taburet
(p. 125)

No. 1

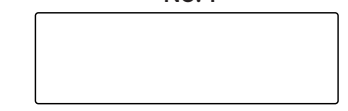

No.17

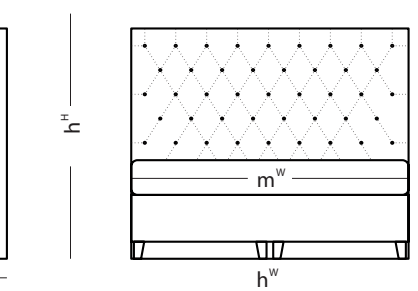
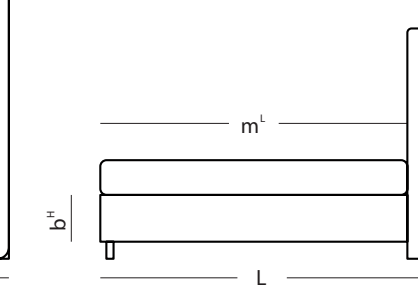
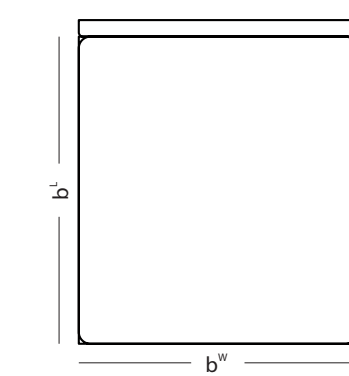
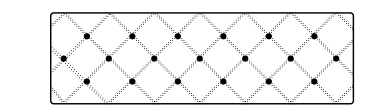



RHOMBUS

	L	b ^L	b ^W	b ^H	h ^W	h ^H	m ^L	m ^W (cm)
BOXSPRING 32	208	200	180	32	180	160	200	180
	208	200	160	32	160	160	200	160

Taburet
(p. 125)

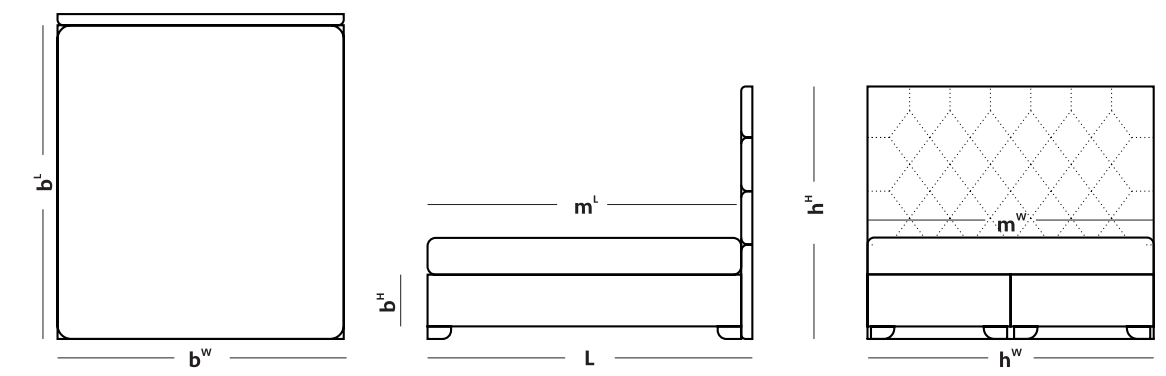
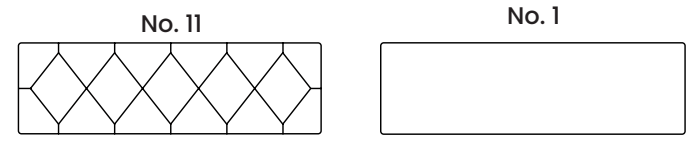



WILD

	L	b ^L	b ^W	b ^H	h ^W	h ^H	m ^L	m ^W (cm)
BOXSPRING 32	208	200	180	32	180	160	200	180
	208	200	160	32	160	160	200	160

Taburet
(p. 125)

No. 16



No. 1

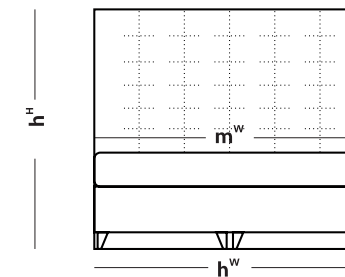
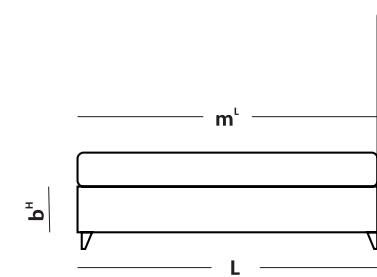
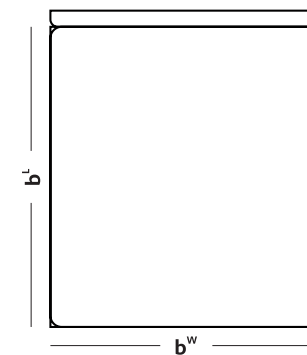



KINGSTONE

	L	b ^L	b ^W	b ^H	b ^D	h ^W	h ^H	m ^L	m ^W (cm)
DESIGN BED	218	205	190	35	5	190	120	200	180
	218	205	170	35	5	170	120	200	160

Taburet
(p. 125)

No. 2

No. 1

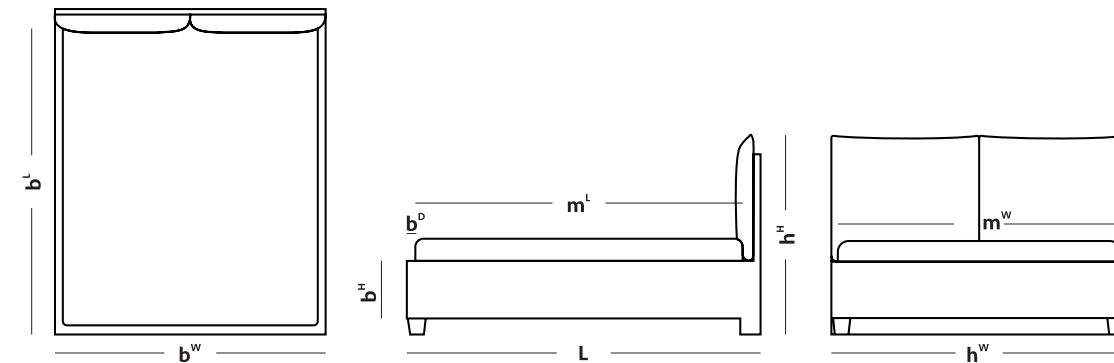
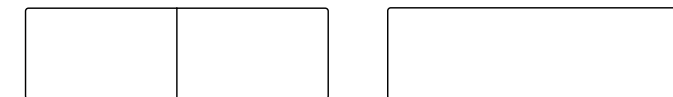



HONEY

	L	b ^L	b ^W	b ^H	b ^D	h ^W	h ^H	m ^L	m ^W (cm)
DESIGN BED	213	205	190	35	5	190	160	200	180
	213	205	170	35	5	170	160	200	160

Taburet
(p. 125)

No. 8

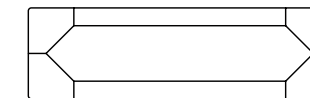

No. 1

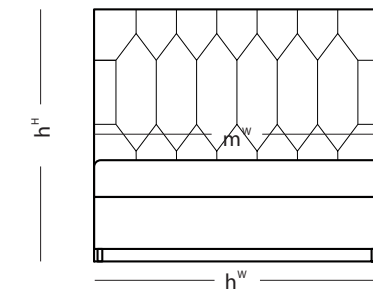
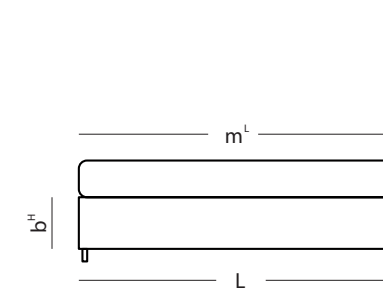
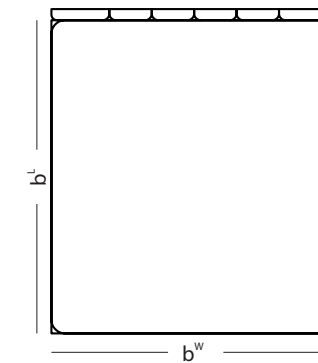

MELVA

	L	b ^l	b ^w	b ^h	h ^w	h ^h	m ^l	m ^w (cm)
BOXSPRING 32	208	200	180	32	186	160	200	180
	208	200	160	32	166	160	200	160

Taburet
(p. 125)

No. 13

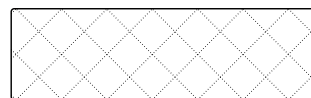

No. 1

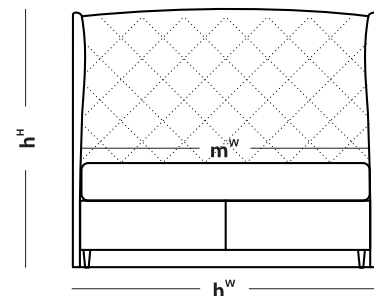
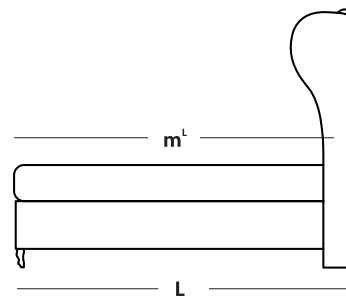
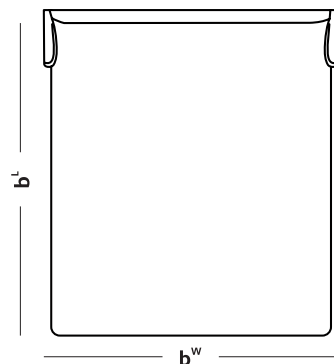

SPECTRA

	L	b ^l	b ^w	b ^h	h ^w	h ^h	m ^l	m ^w (cm)
MAXI	208	200	180	32	180	130	200	180
	208	200	160	32	160	130	200	160

Taburet
(p. 125)

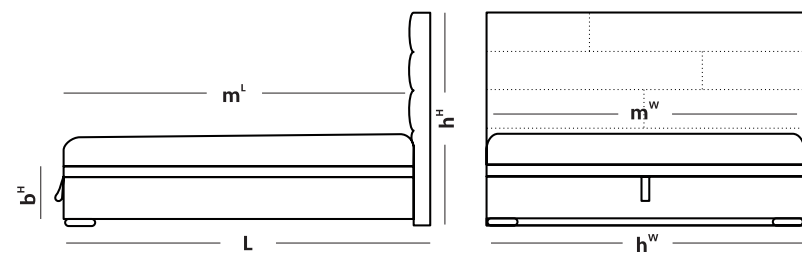
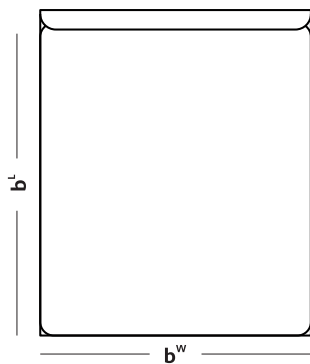
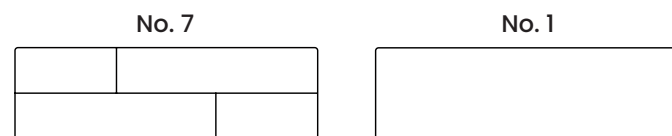

HORIZONTAL

	L	b ^L	b ^W	b ^H	h ^{W1}	h ^{W2}	h ^H	m ^L	m ^W (cm)
MAXI	210	200	180	32	180	240	145	200	180
	210	200	160	32	160	220	145	200	160

Taburet
(p. 125)

No. 3



No. 1

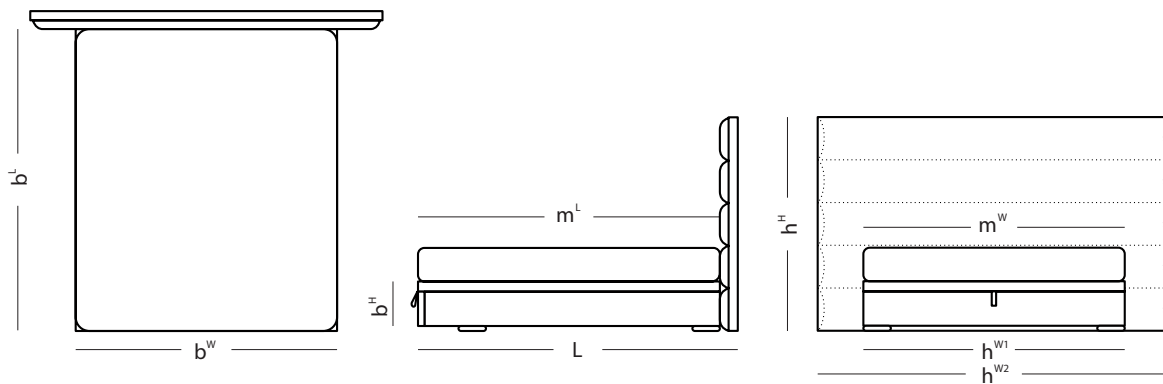

NAVY

	L	b ^L	b ^W	b ^H	b ^D	h ^W	h ^H	m ^L	m ^W (cm)
DESIGN BED	213	205	190	30	5	190	123	200	180
	213	205	170	30	5	170	123	200	160

Taburet
(p. 125)

No. 1

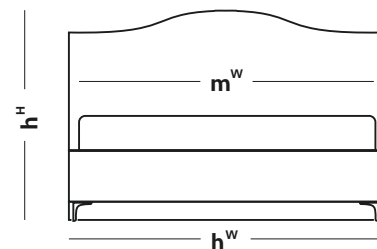
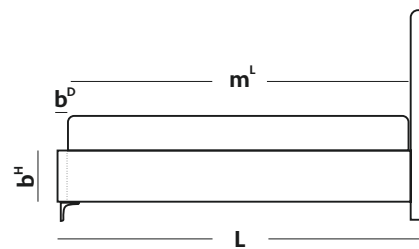
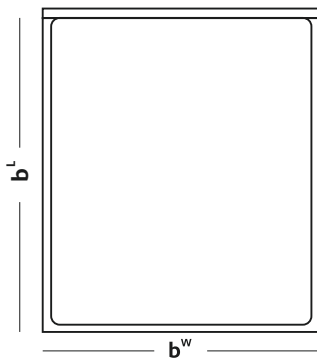

ENIF

	L	b ^L	b ^W	b ^H	b ^D	h ^W	h ^H	m ^L	m ^W (cm)
DESIGN BED	213	205	190	35	5	196	123	200	180
	213	205	170	35	5	176	123	200	160

Taburet
(p. 125)

No. 1

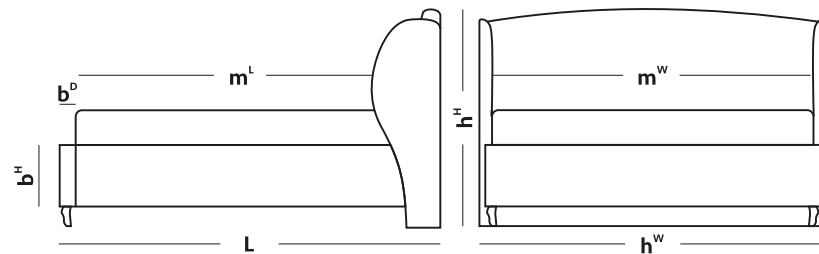
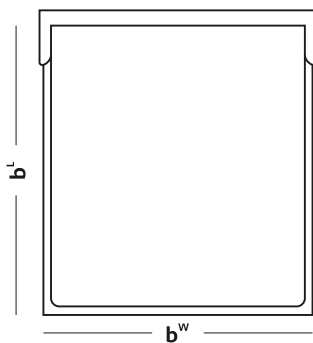

GEMINI

	L	b ^l	b ^w	b ^h	b ^p	h ^w	h ^h	m ^l	m ^w (cm)
DESIGN BED	213	205	190	30	5	190	150	200	180
	213	205	170	30	5	170	150	200	160

Taburet
(p. 125)

No. 6

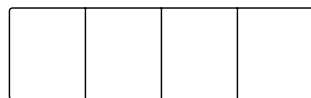

No. 1

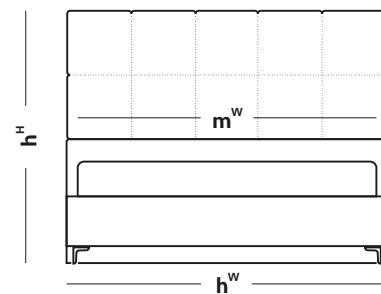
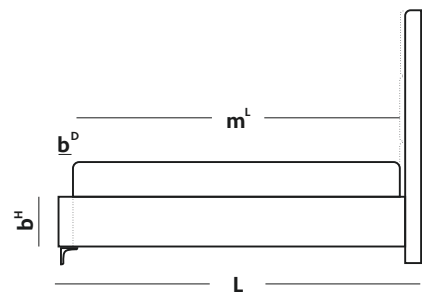
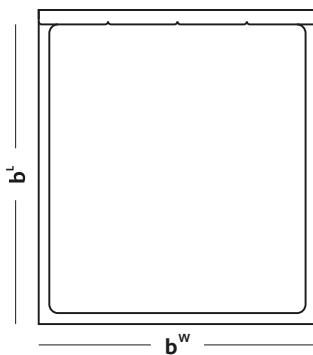



FRANCESCA LUX

	L1 L2	b ^L	b ^W	b ^H	b ^D	h ^W	h ^H	m ^L	m ^W (cm)
DESIGN BED	231 216	205	190	30	5	190	103	200	180
	231 216	205	170	30	5	170	103	200	160

Taburet
(p. 125)

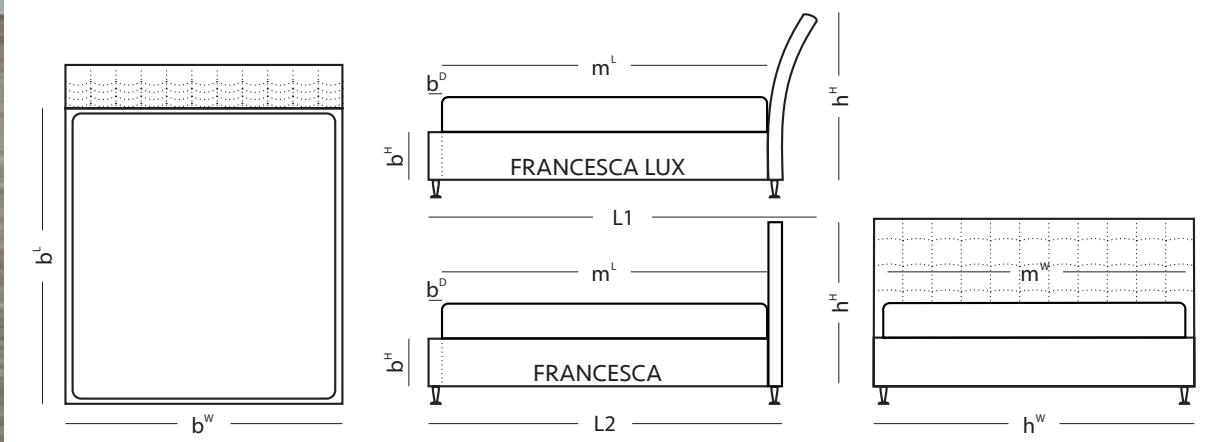
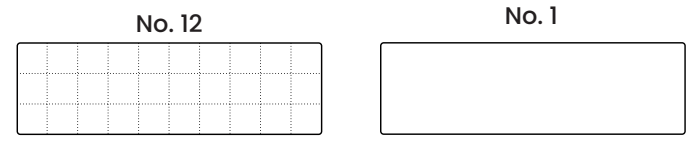



CLAUDIA LUX

	L1 L2	b ^L	b ^W	b ^H	b ^D	h ^W	h ^H	m ^L	m ^W (cm)
DESIGN BED	234 219	208	196	30	8	196	103	200	180
	234 219	208	176	30	8	176	103	200	160

Taburet
(p. 125)

No. 16

No. 1

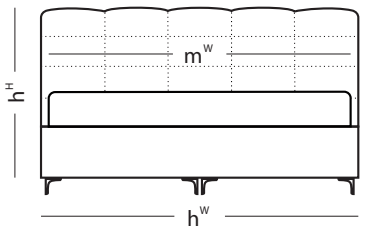
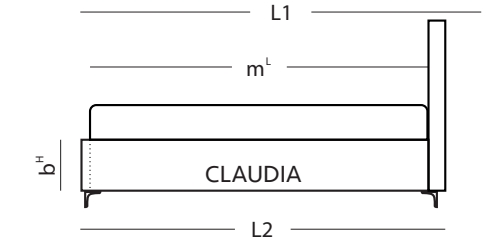
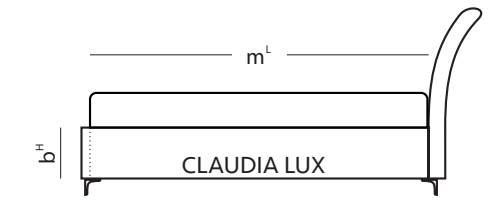
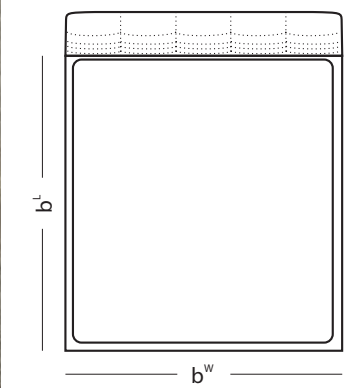
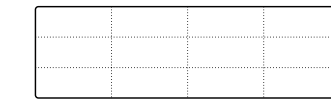

ALESIA

	L	b ^L	b ^W	b ^H	b ^D	h ^W	h ^H	m ^L	m ^W (cm)
DESIGN BED	217	205	190	30	5	190	103	200	180
	217	205	170	30	5	170	103	200	160

Taburet
(p. 125)

No. 13



No. 1

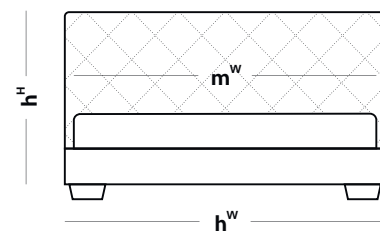
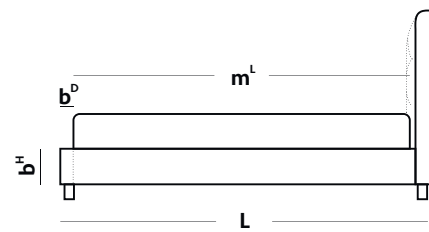
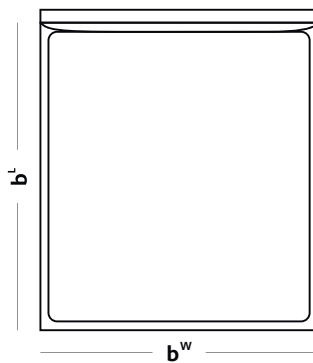



VEGA

	L	b ^L	b ^W	b ^H	b ^D	h ^W	h ^H	m ^L	m ^W (cm)
DESIGN BED	213	205	190	30	5	190	130	200	180
	213	205	170	30	5	170	130	200	160

Taburet
(p. 125)

No. 6

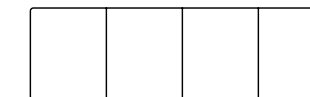

No. 1

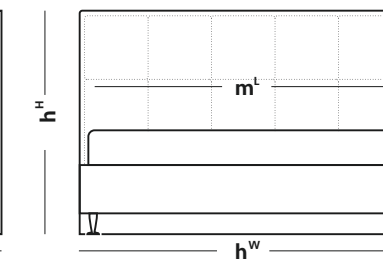
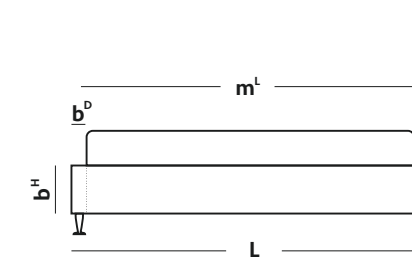
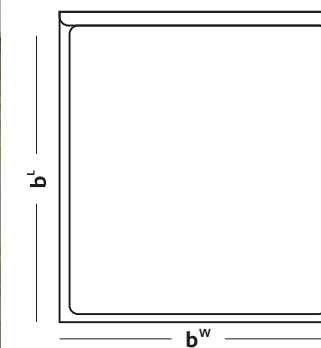



BELLATRIX

	L	b ^L	b ^W	b ^H	b ^D	h ^W	h ^H	m ^L	m ^W (cm)
DESIGN BED	213	205	190	35	5	190	120	200	180
	213	205	170	35	5	170	120	200	160

Taburet
(p. 125)

No. 10

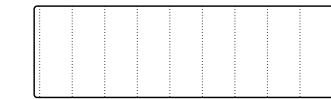

No. 1

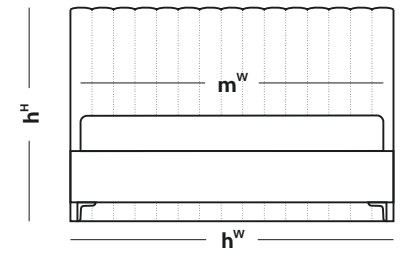
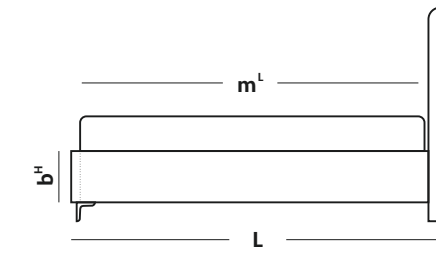
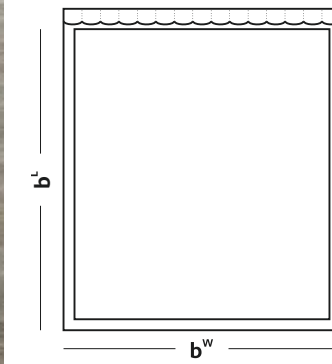

ATLAS

	L	b ^l	b ^w	b ^h	h ^w	h ^h	m ^l	m ^w (cm)
BOXSPRING 22	225	200	180	22	180	100	200	180
	225	200	160	22	160	100	200	160

Taburet
(p. 125)

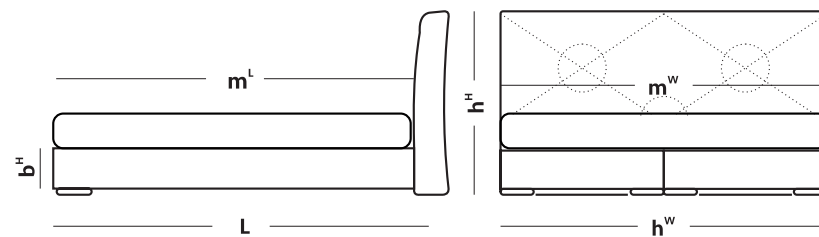
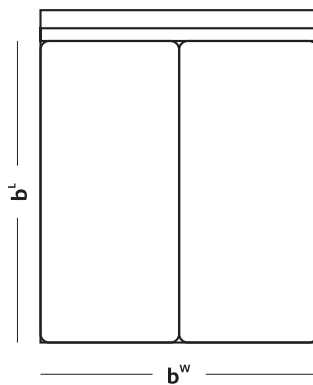
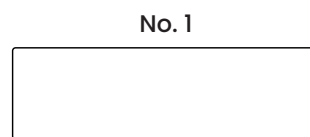
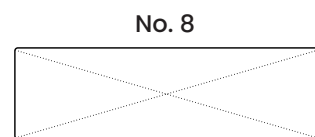

CORONA

	L	b ^l	b ^w	b ^h	h ^w	h ^h	m ^l	m ^w (cm)
MAXI	208	200	180	32	180	120	200	180
	208	200	160	32	160	120	200	160

Taburet
(p. 125)

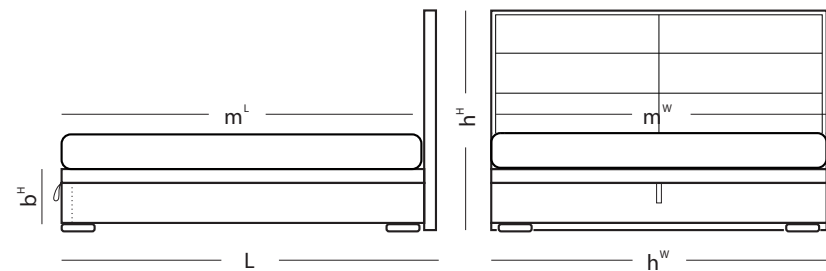
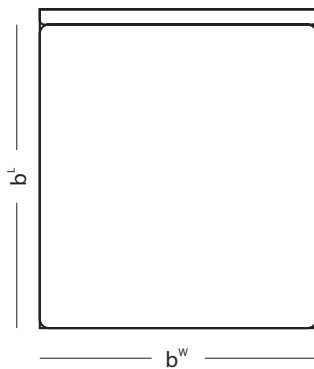
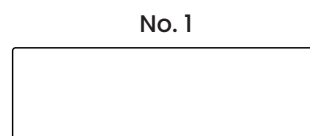
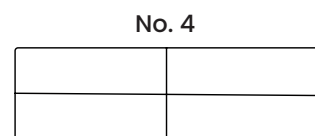

PARIS

	L	b ^L	b ^W	b ^H	h ^W	h ^H	m ^L	m ^W (cm)
BOXSPRING 32	208	200	180	32	180	197	200	180
+ COVER	208	200	160	32	160	197	200	160

Taburet
(p. 125)

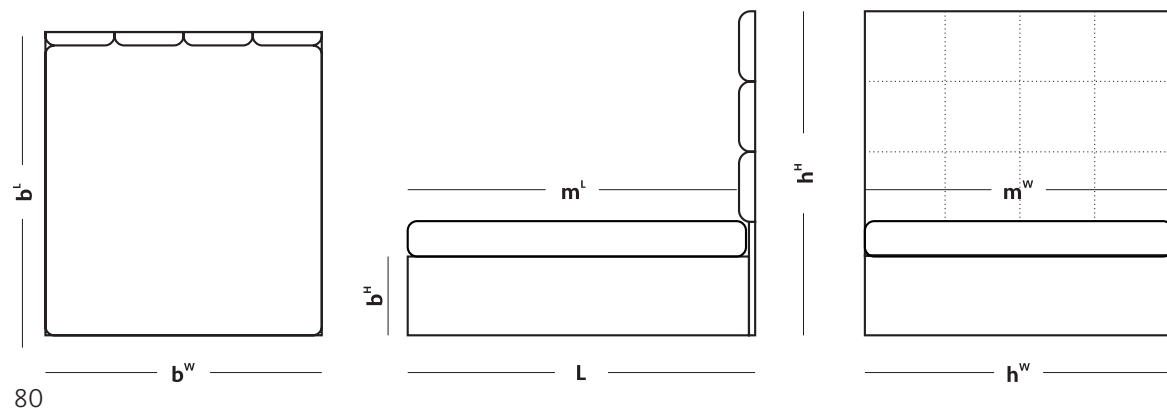
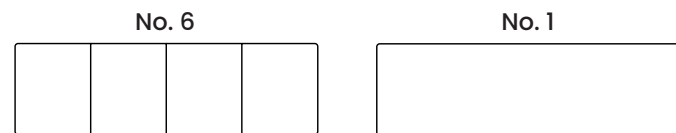

VIENNA

	L	b ^L	b ^W	b ^H	h ^W	h ^H	m ^L	m ^W (cm)
BOXSPRING 32	208	200	180	32	190	160	200	180
	208	200	160	32	170	160	200	160

Taburet
(p. 125)

No. 15

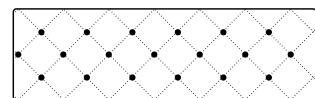

No. 1

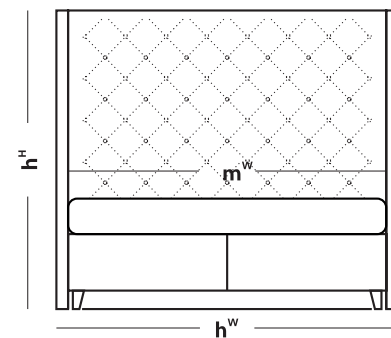
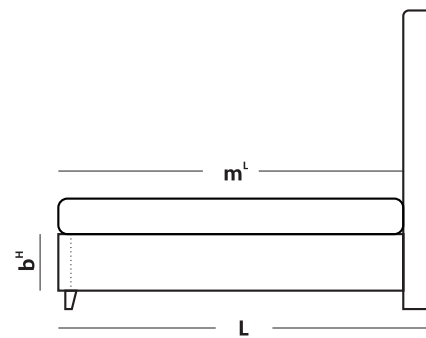
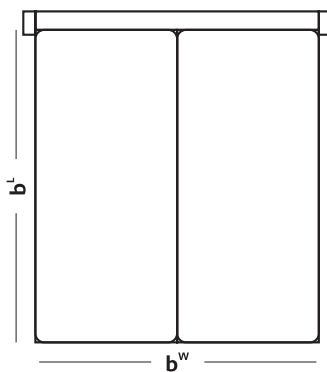

NOBILIA

	L	b ^L	b ^W	b ^H	b ^D	h ^W	h ^H	m ^L	m ^W (cm)
DESIGN BED	213	205	190	30	5	190	120	200	180
	213	205	170	30	5	170	120	200	160

Taburet
(p. 125)

No. 9



No. 1

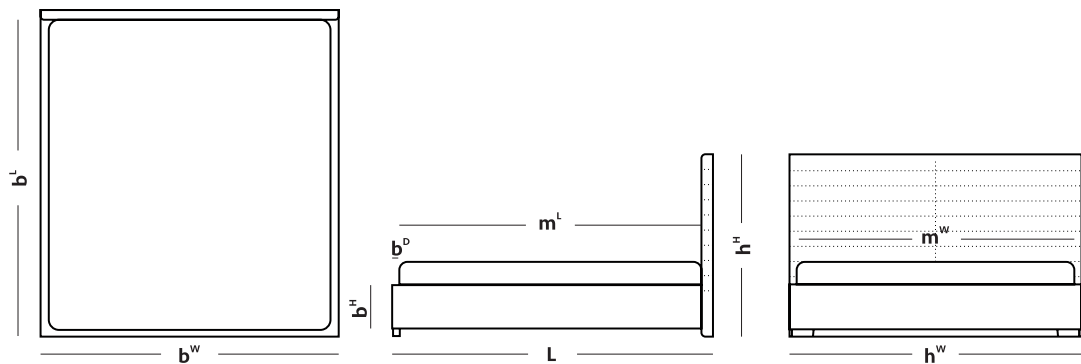



ARGENTINA

	L	b ^L	b ^W	b ^H	b ^D	h ^W	h ^H	m ^L	m ^W (cm)
DESIGN BED	213	205	190	35	5	190	120	200	180
	213	205	170	35	5	170	120	200	160

Taburet
(p. 125)

No. 1

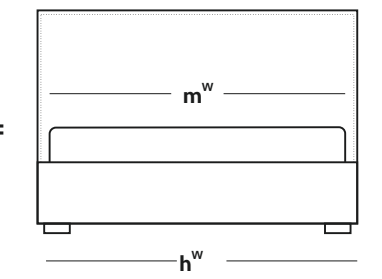
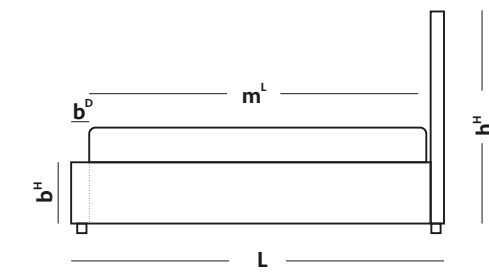
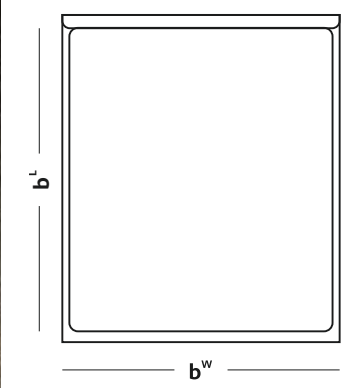



SIRIUS

	L	b ^L	b ^W	b ^H	h ^W	h ^H	m ^L	m ^W (cm)
BOXSPRING MOBIL	208	200	180	32	180	120	200	180
	208	200	160	32	160	120	200	160

Taburet
(p. 125)

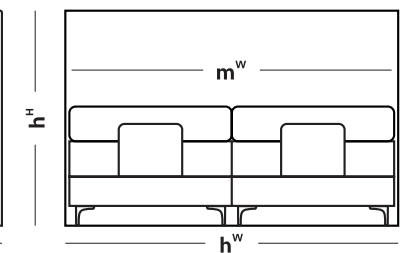
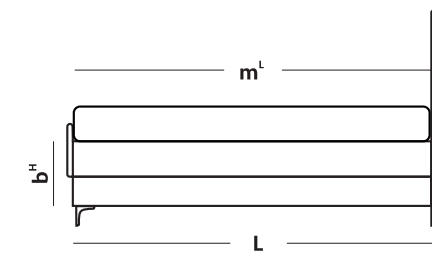
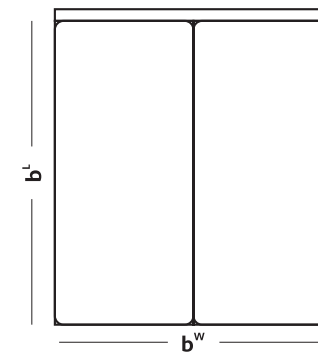
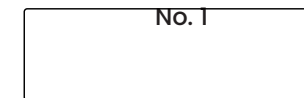



VELORUM

	L	b ^L	b ^W	b ^H	h ^W	h ^H	m ^L	m ^W (cm)
BOXSPRING 32	208	200	180	32	180	120	200	180
	208	200	160	32	160	120	200	160

Taburet
(p. 125)

No. 14

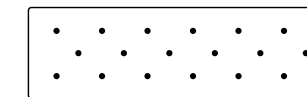

No. 1

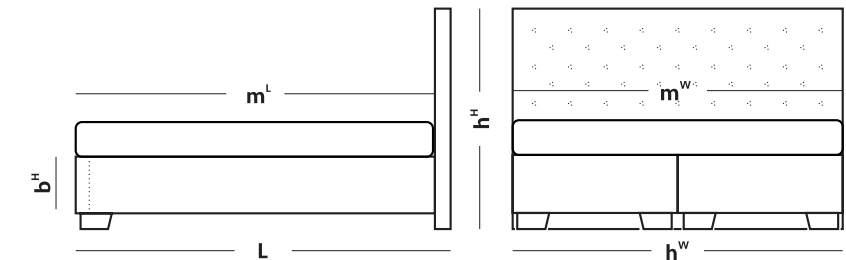
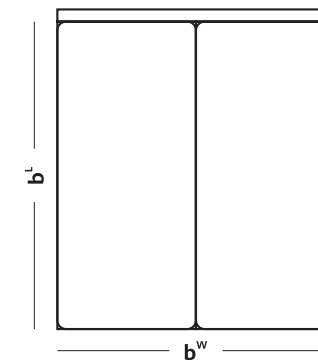



CORIUM SLIDE

NEW

	L	b ^L	b ^W	b ^H	h ^W	h ^H	m ^L	m ^W (cm)
BOXSPRING	210	200	95	46	105	120	200	95
Slide							185	90

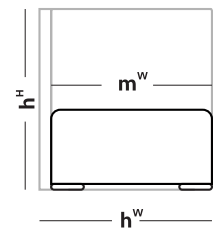
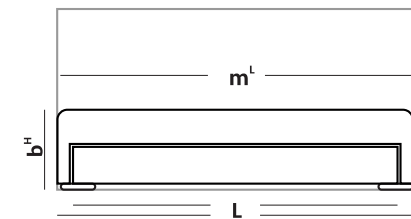
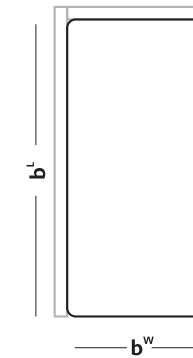



WALL

NEW

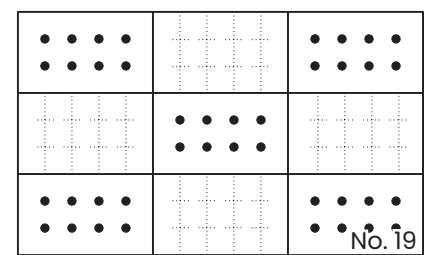
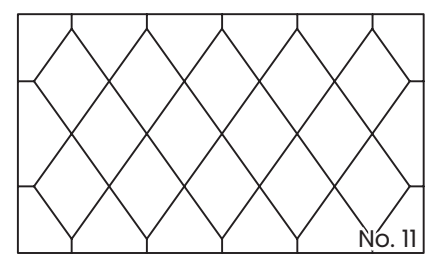
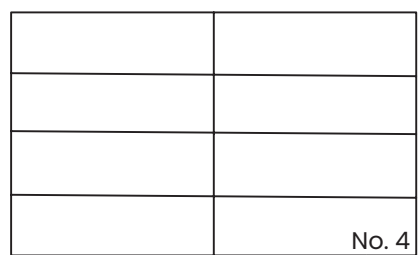
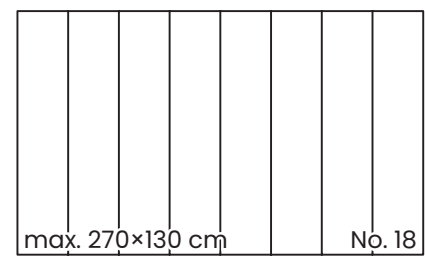
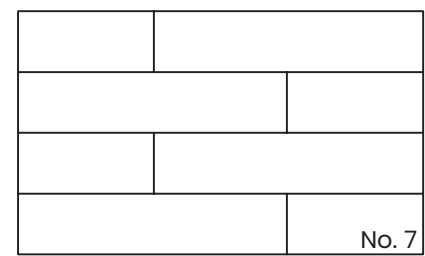
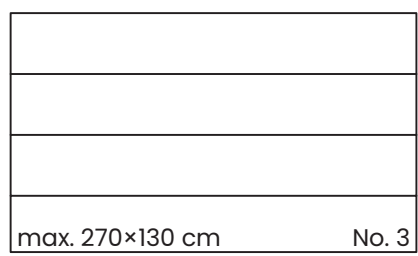
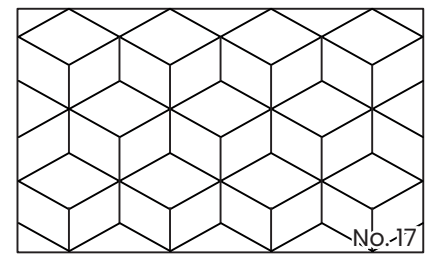
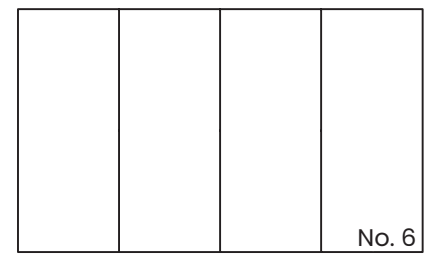
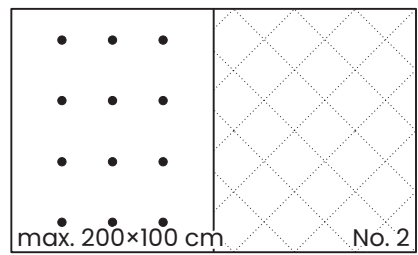



TWINS

NEW

L	b ^w	b ^H	b ^{H1}	b ^{H2}	m ^L	m ^w (cm)
224	100	197	30	154	200	90

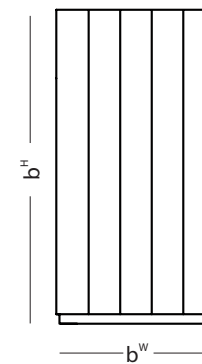
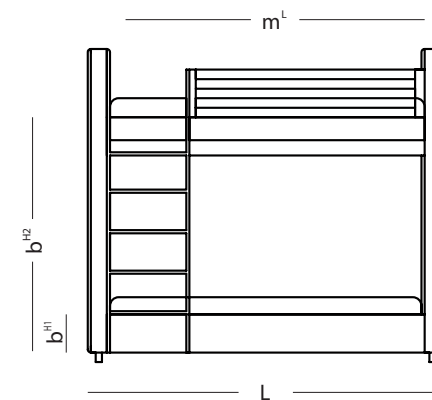
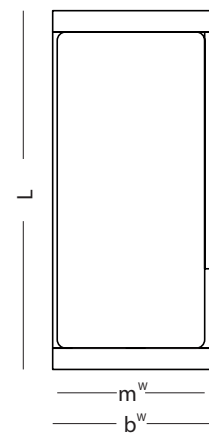

NEW



AMIRA

L	b	h	L ^r	h ^r	L ^w	h ^w (cm)
200	80/90	22 - 45	70	23	80/90	28

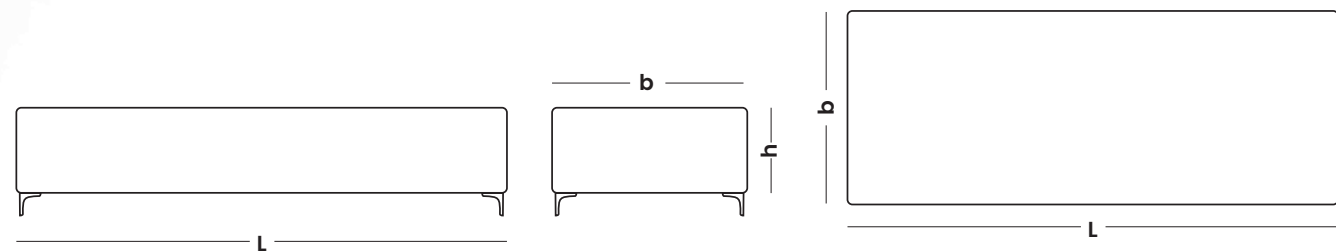
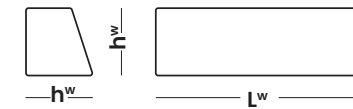
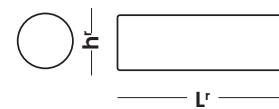

NEW



SIESTA

a	b	c	d	e	f	g	h	L (cm)
80	88	40	75	14	5	60	86	188

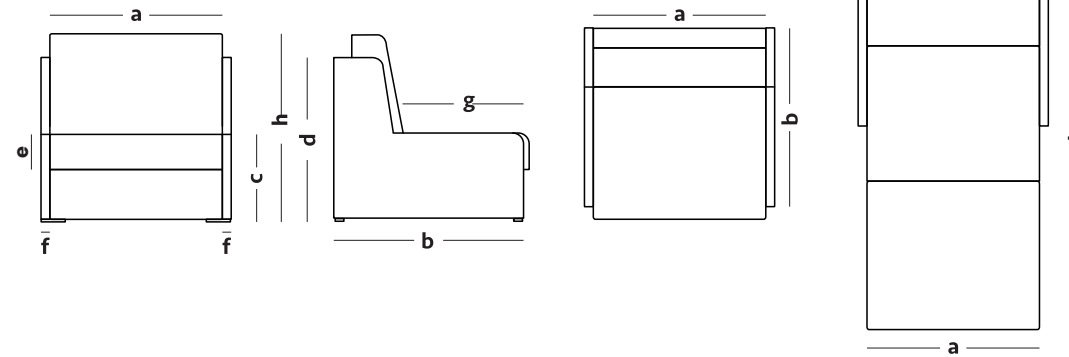

NEW



SOFABED BARI

	a	b	c	d	e	f	g	m ^l	m ^w	L (cm)
BARI DOUBLE	210	49	68	100	62	30	152	190	140	240
BARI TRIPLE	230	49	68	100	62	30	172	190	160	240

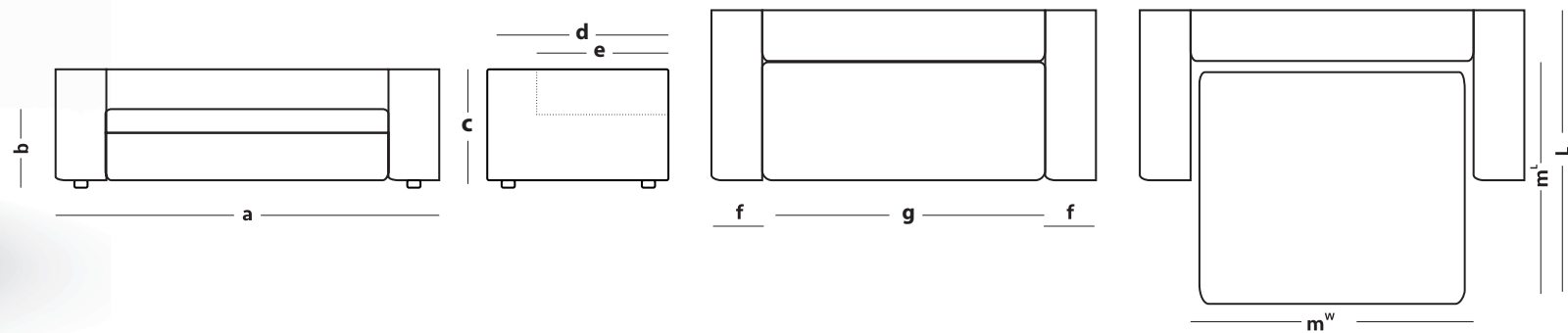

NEW



SOFABED TORVI

	a	b	c	d	e	f	g	h	m ^l	m ^w	L (cm)
SOFABED DOUBLE	163	93	55	56	183	10	60	96	190	140	215
SOFABED TRIPLE	183	93	55	56	203	10	60	96	190	160	215

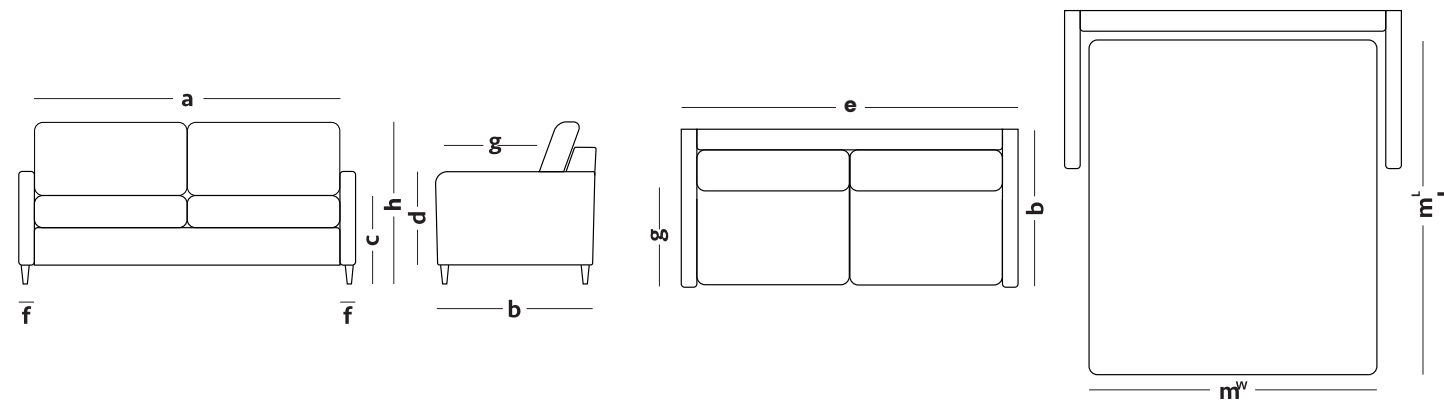



SOFABED SINGLE

a	b	c	d	f	g	h	m ^l	m ^w	L	(cm)
80	98	48	60	13 17 21	55	85	190	80	215	

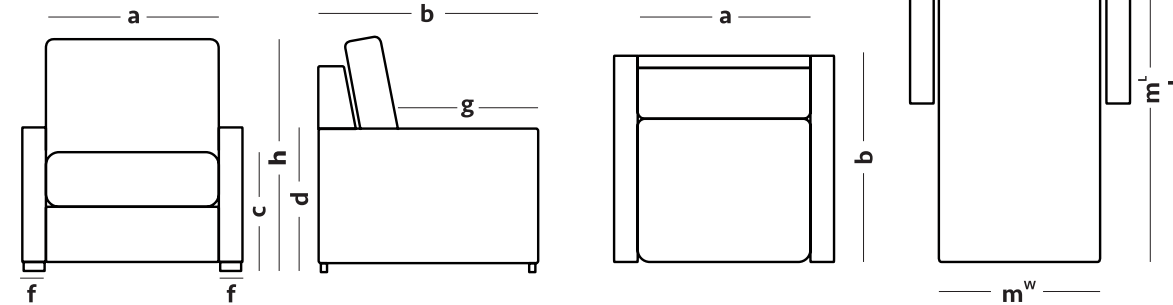



SOFABED DOUBLE

	a	b	c	d	f	g	h	m ^l	m ^w	L (cm)
SOFABED DOUBLE	163	98	48	60	13 17 21	55	85	190	140	215
SOFABED TRIPLE	183	98	48	60	13 17 21	55	85	190	160	215

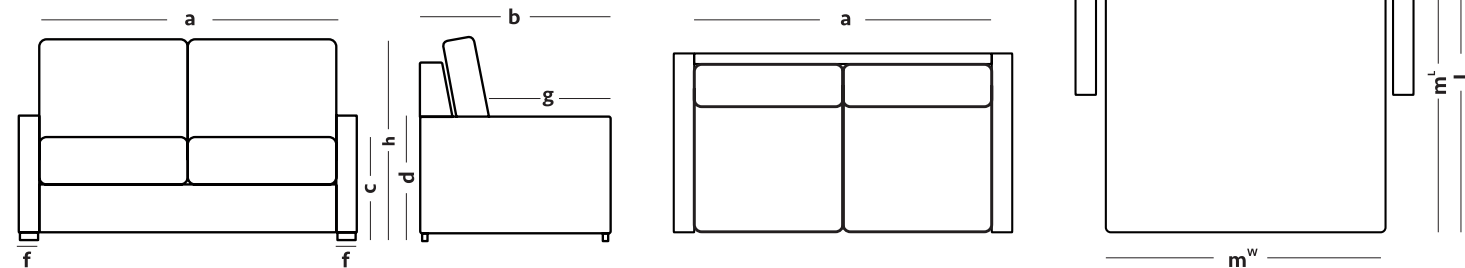

BOUDOIR MONT BLANC

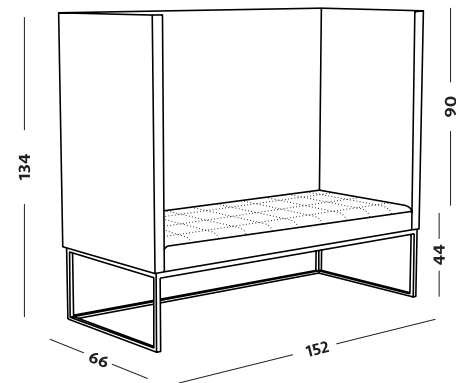

MONT BLANC

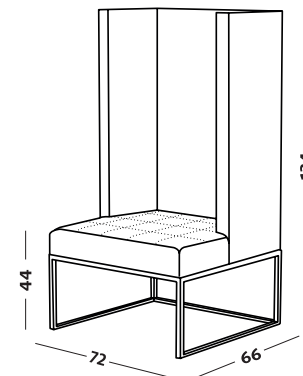

NEW

BOSS



a	b	c	d	e	f	g	h	i	(cm)
50	50	105	95	50	50	78	95	30	

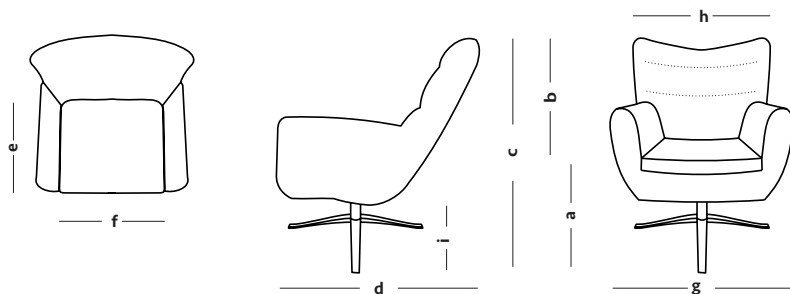

MOON



a	b	c	d	(cm)
93	90	45	63	

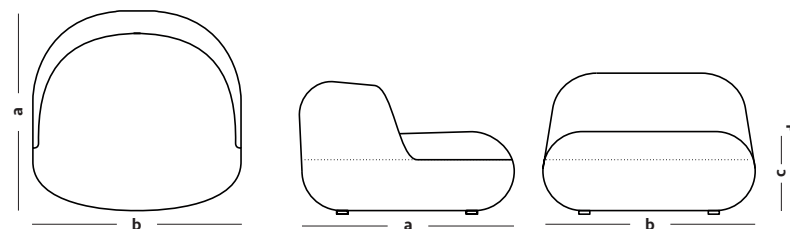

PUFF

NEW

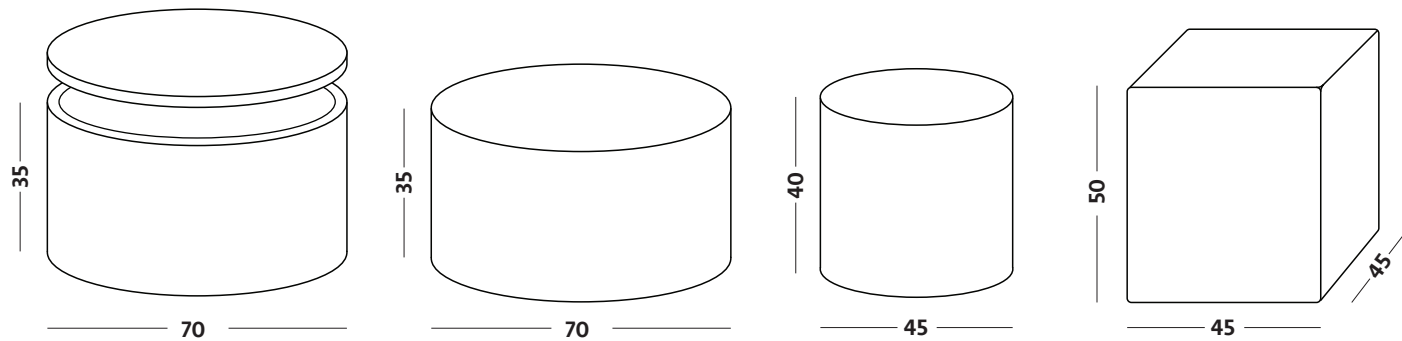

NAEL

MONI

OLI

TINA

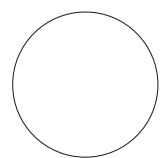

No. 1

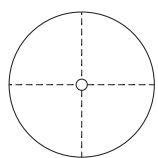

No. 2

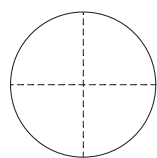

No. 3

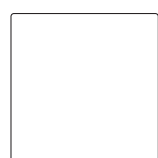

No. 1

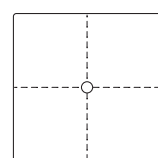

No. 2

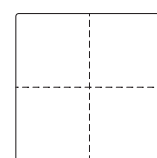

No. 3



NEW



BOUDOIR BREEZE

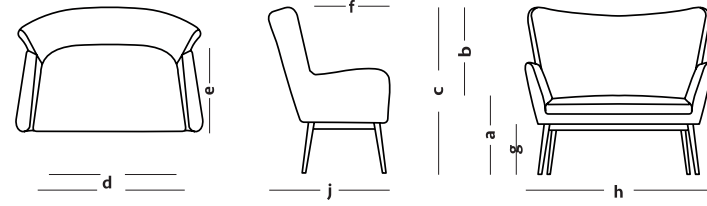

	a	b	c	d	e	f	g	h	j	(cm)
CROSS	45	53	98	116 100	56	54	31	140	84	

BREEZE

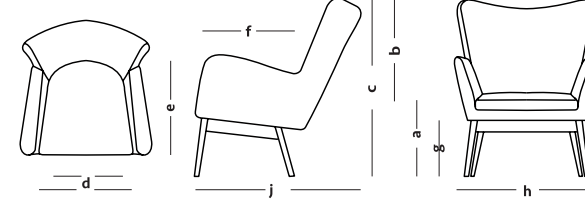

	a	b	c	d	e	f	g	h	j	(cm)
CUT	45	63	94	56 42	56	42	26 31	78	85	
CROSS	45	63	102	56 42	56	42	32	78	80	

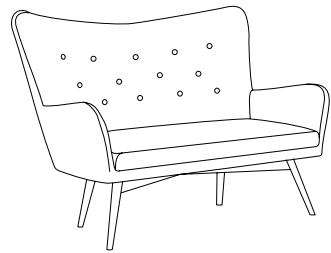

Button

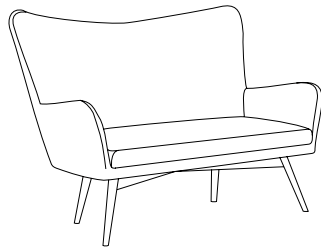

Clean

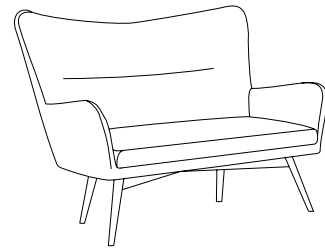

Mirach

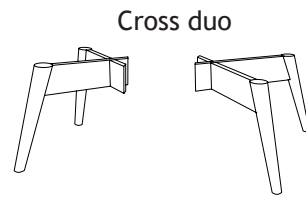

Cross duo

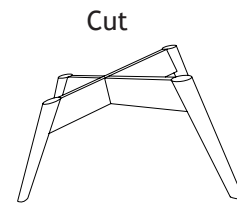

Cut

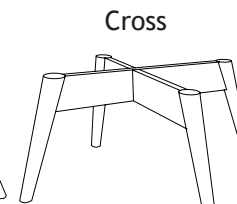

Cross

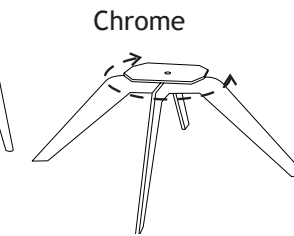

Chrome

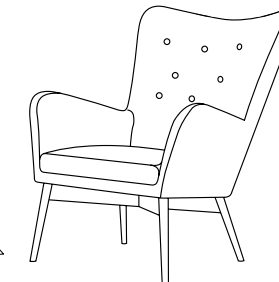

Button

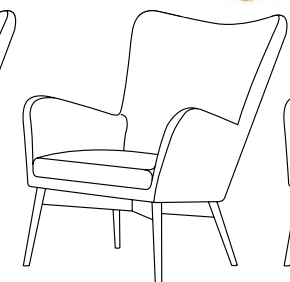

Clean

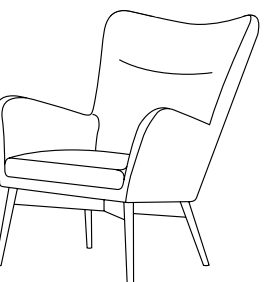

Mirach



DE LUXE

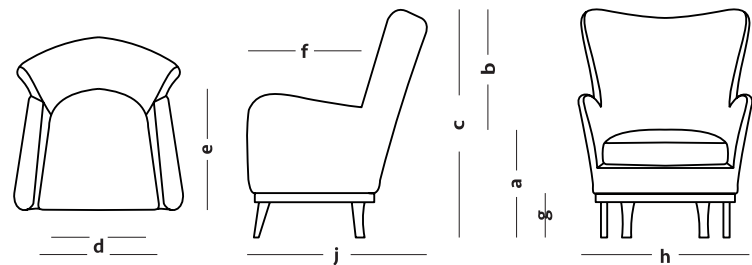

	a	b	c	d	e	f	g	h	j	(cm)
CASTEL	45	55	100	56 42	54	49	20	79	80	
LINE	46	55	101	56 42	54	49	21	79	80	

MODERN

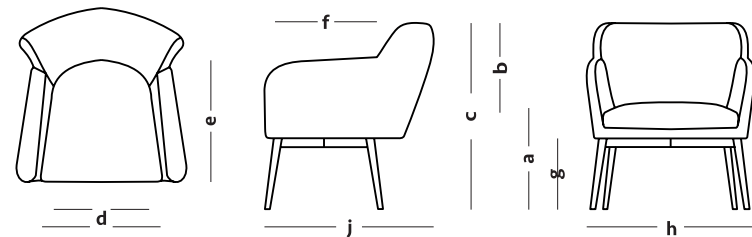

	a	b	c	d	e	f	g	h	j	(cm)
CUT	45	33	69	55 44	56	42	26 31	75	79	
CROSS	45	33	78	55 44	56	42	32	75	75	

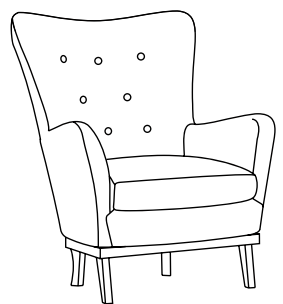

Button

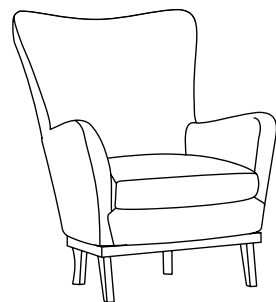

Clean

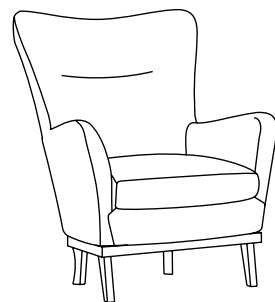

Mirach

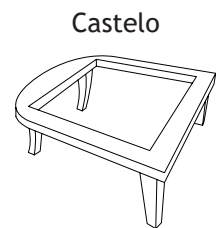

Castelo

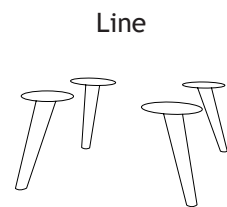

Line

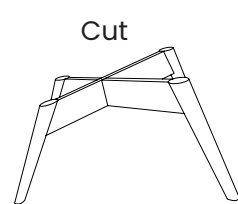

Cut

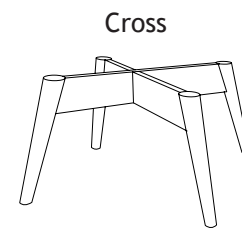

Cross

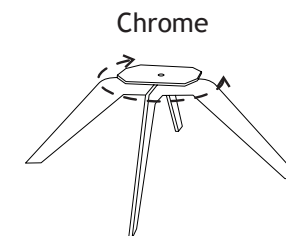

Chrome

CUT

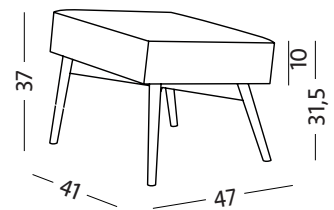

CASTELO

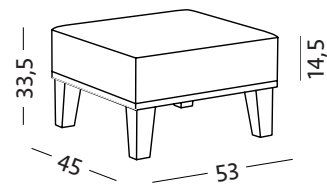

CROSS

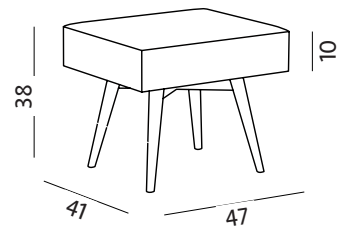

INDUSTRY

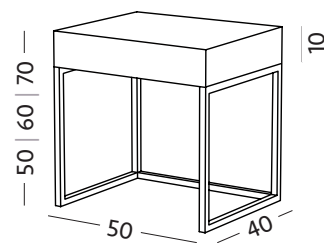

HEAVY OAK

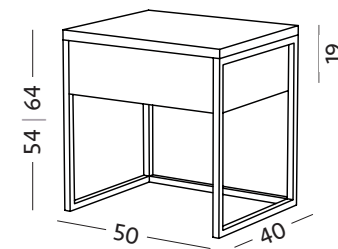

OAK

NEW

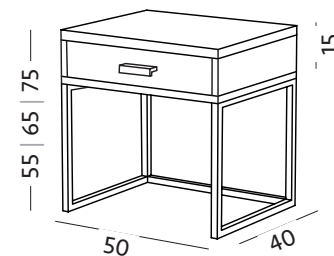

WHITE

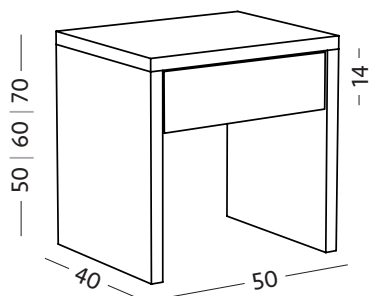

STONE

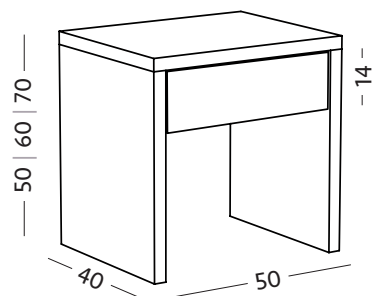

DARK STONE

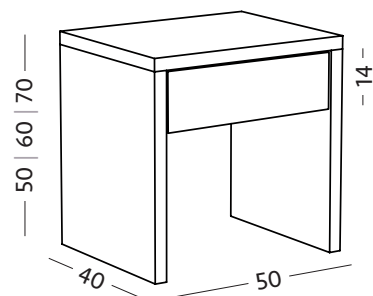

CUBE

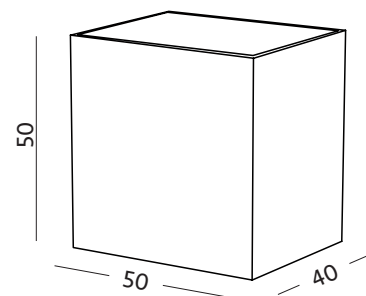

DAMIANI

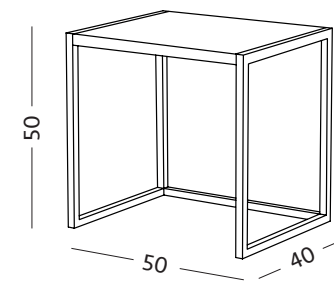

BIANCA

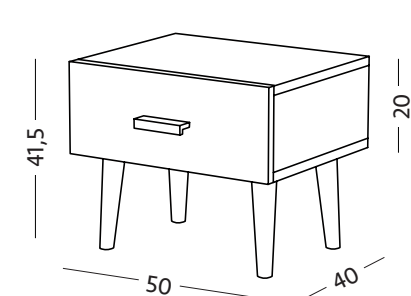

TABURET | BENCH

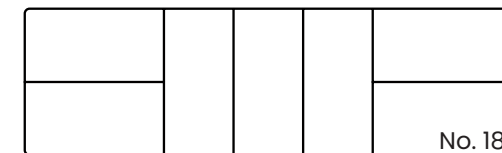
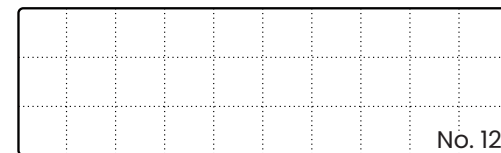
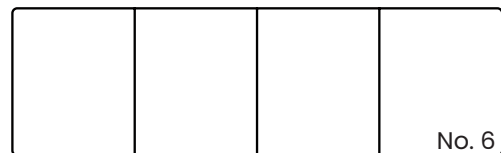
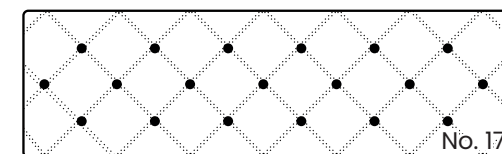
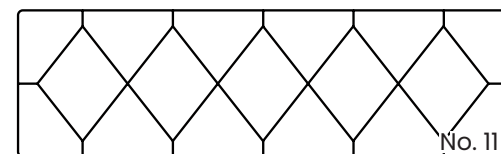
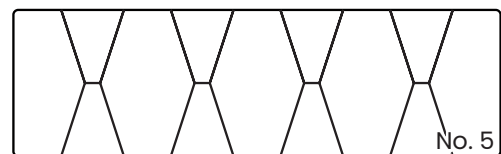
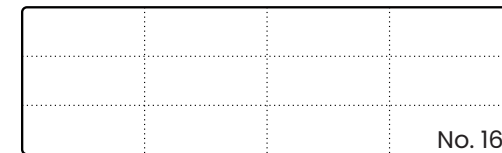
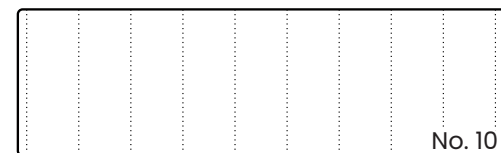
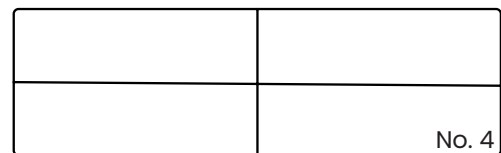
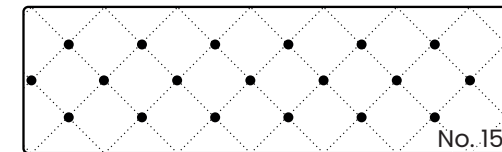
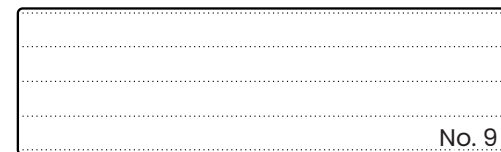
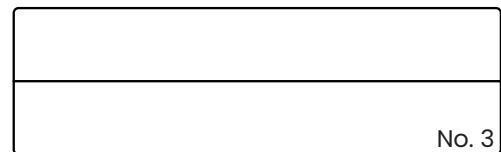
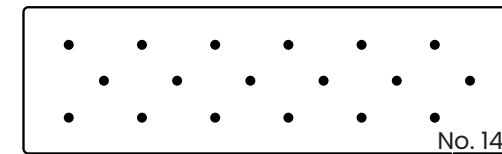
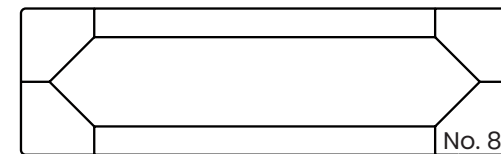
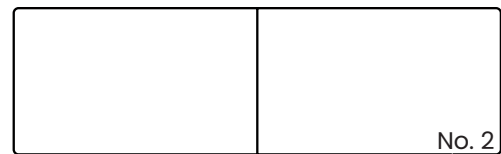
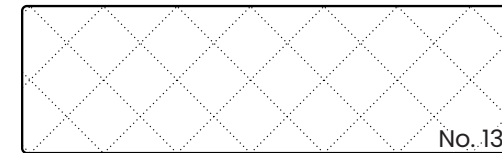
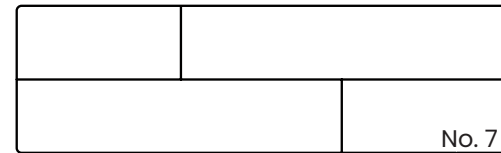
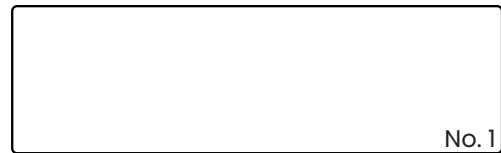
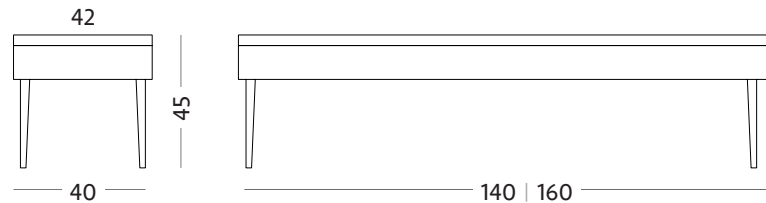
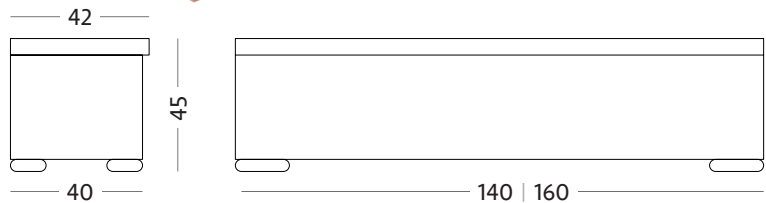

NEW



Flute

120 | 150 | 190 mm - black, bronze, chrome, gold

NEW



Line

120 | 150 | 220 mm - chrome, black, white

NEW



Light

150 mm - black



NEW

Floor angle

200×200×20 mm - chrome

NEW



Floor tube

200 mm × 32 mm - chrome



Floor

150×150×30 mm - chrome

NEW



Capri

200 mm - black | 190 mm - chrome

NEW



Dual

150 mm - black

NEW



Spider

120 | 150 mm - chrome



Fancy

130 mm - chrome



Industry

130 mm - black



Elegance

130 mm - black, white, chrome, gold



Polygon

100 mm - chrome



Metal

80 mm - chrome

NEW



Block ·

100 | 130 | 160 mm – natur, walnut, gray, wenge, black



Wood 1

88 | 100 | 130 mm – natur, gray, walnut, wenge, black



Tulip

130 mm – natur



Castello

130 mm – walnut



Cube

100 mm – cherry



Wood 2

80 mm – natur, walnut, gray, wenge, black



Wood 4

110 mm – natur, walnut, gray, wenge, black



Wood 5

110 mm – natur, walnut, gray, wenge, black

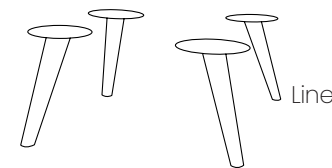

Line

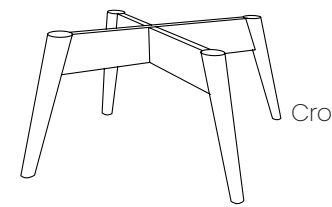

Cross

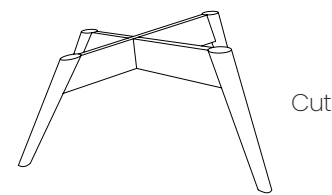

Cut

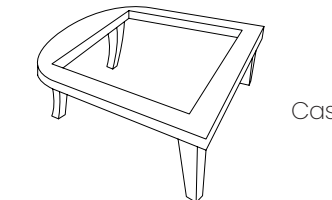

Castello

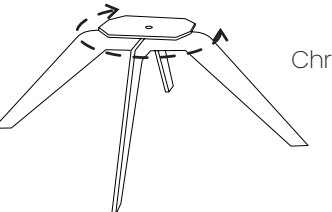

Chrome



Natur

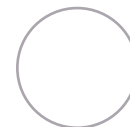

White

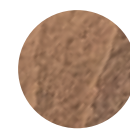

Walnut

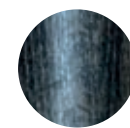

Wenge



- SK** Obsah katalógu je duševným vlastníctvom firmy Materasso Slovakia s. r. o. Použit' tieto materiály je možné len s uvedením ich vlastníka: © Materasso Slovakia s. r. o. Nedodržanie týchto podmienok je právne **vymáhateľné ako porušenie autorských práv**. Farby použitých materiálov sú ilustračné, môžu byť odlišné od skutočnosti.
- CZ** Obsah katalogu je duševním vlastníctvím firmy Materasso Slovakia s. r. o. Použit' tyto materiály lze pouze s uvedením jejich vlastníka: © Materasso Slovakia s. r. o. Nedodržení těchto podmínek je právně **vymáhateľné jako porušení autorských práv**. Barvy použitých materiálů jsou ilustrační, mohou být odlišné od skutečnosti.
- EN** The content of the catalogue is the intellectual property of Materasso Slovakia s. r. o. It is possible to use these materials only with the indication of their owner: © Materasso Slovakia s. r. o. Failure to comply with these terms and conditions is legally **enforceable as copyright infringement**. The colors of the materials used are illustrative, they may differ from the actual ones.
- PL** Zawartość katalogu jest własnością intelektualną Materasso Slovakia s. r. o. Korzystanie z tych materiałów jest możliwe tylko za wskazaniem ich właściciela: © Materasso Slovakia s. r. o. Nieprzestrzeganie tych warunków jest prawnie **egzekwowalne jako naruszenie praw autorskich**. Kolory użytych materiałów mają charakter poglądowy, mogą różnić się od rzeczywistych.
- HU** A katalógus tartalma a Materasso Slovakia s. r. o. szellemi tulajdonát képezi. Ezeket az anyagokat csak a tulajdonos feltüntetésével lehet felhasználni: © Materasso Slovakia s. r. o. E feltételek be nem tartása jogilag **érvényesíthető szerzői jogsértésként**. A felhasznált anyagok színei illusztrációs célokat szolgálnak, és eltérhetnek a valóságtól.
- DE** Der Inhalt des Katalogs ist geistiges Eigentum von Materasso Slovakia s. r. o. Die Nutzung dieser Materialien ist nur mit Angabe des Eigentümers möglich: © Materasso Slovakia s. r. o. Die Nichteinhaltung dieser Bestimmungen und Bedingungen kann als **Urheberrechtsverletzung rechtlich verfolgt werden**. Die Farben der verwendeten Materialien sind illustrativ, sie können von den tatsächlichen abweichen.

m
Materasso
www.materasso.eu
2025

